



**RAYCHEM**

# Raystat

Version 5 (EU)

<b>PART 1</b>	<b>INSTALLATION MANUAL</b> .....	<b>1</b>
	<b>PRODUCT OVERVIEW</b>	
	<b>INSTALLATION INSTRUCTIONS</b>	
<b>EN</b>	INSTALLATION NOTES .....	8
<b>DE</b>	INSTALLATIONSHINWEISE .....	12
<b>FR</b>	CONSIGNES D'INSTALLATION .....	16
<b>SV</b>	INSTALLATIONSANMÄRKNINGAR .....	20
<b>NO</b>	INSTALLASJONSMANUAL .....	24
<b>FI</b>	ASENNUSTA KOSKEVAT HUOMAUTUKSET .....	28
<b>DK</b>	INSTALLATIONSBEMÆRKNINGER .....	32
<b>NL</b>	INSTALLATIEOPMERKINGEN .....	36
<b>PL</b>	UWAGI DOTYCZĄCE MONTAŻU .....	40
<b>CZ</b>	POZNÁMKY K INSTALACI .....	44
<b>ZH</b>	安装注意事项 .....	48
<b>RU</b>	УКАЗАНИЯ ПО МОНТАЖУ .....	52
<b>LT</b>	PASTABOS DĖL MONTAVIMO .....	56
<b>IT</b>	NOTE PER L'INSTALLAZIONE .....	60
<b>PART 2</b>	<b>OPERATION MANUAL</b> .....	<b>64</b>
	<b>PROGRAM START - QUICK GUIDE</b>	
	<b>DISPLAY</b>	
	<b>PARAMETER SETTING</b>	
<b>PART 3</b>	<b>ELECTRICAL SCHEME</b> .....	<b>84</b>

# PART 1 INSTALLATION MANUAL

## 1.1 PRODUCT OVERVIEW

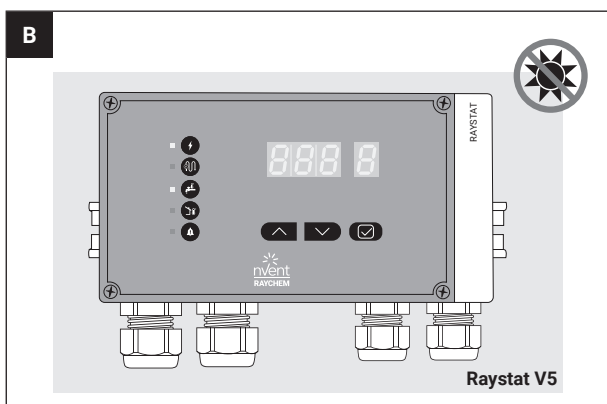
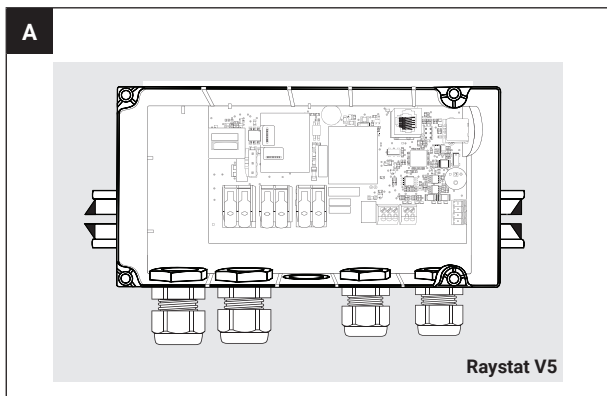

**C**

	 1x	 1x	 1x
	 2x M25; 2x M20	 1x	 1x
	 1x	 2x      2x	 1x
	 PCN: 1244-020365	 PCN: 1244-015847	

## 1.2 INSTALLATION INSTRUCTIONS

1

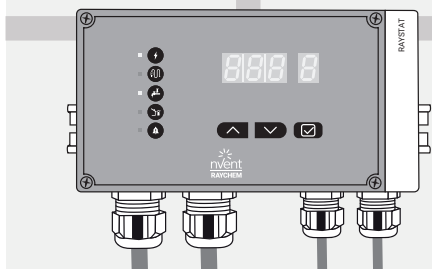

2

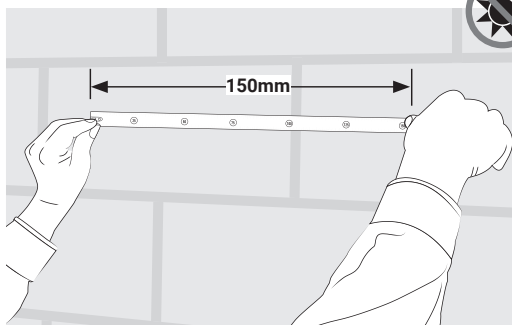

3

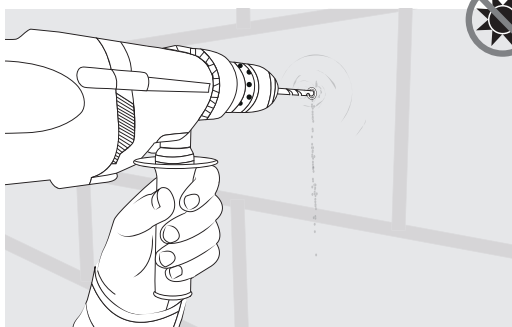

4

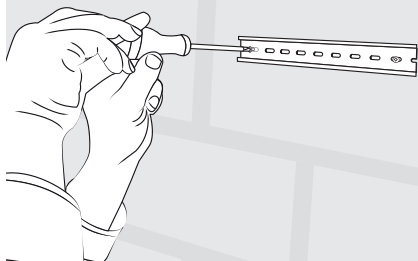

5

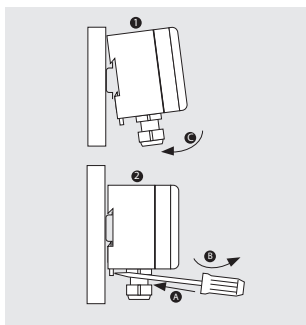

6

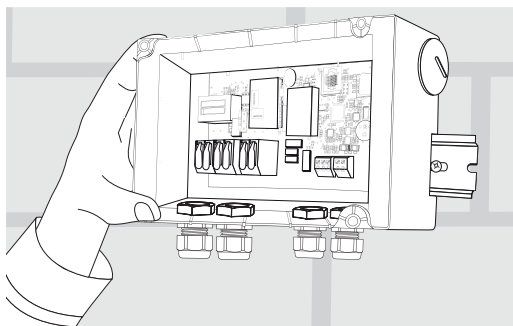

7

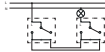

84

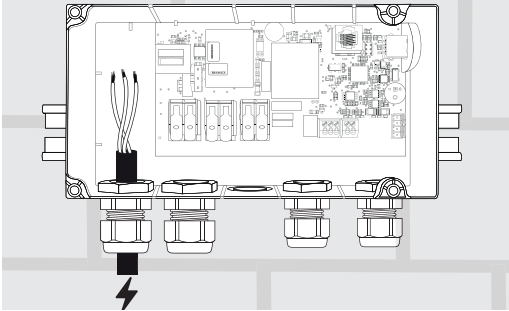

8

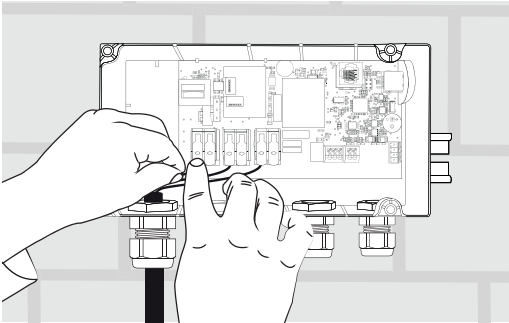

9

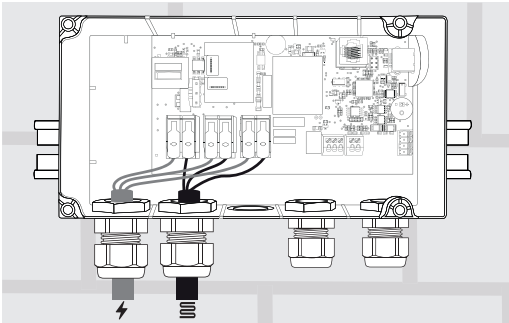

10

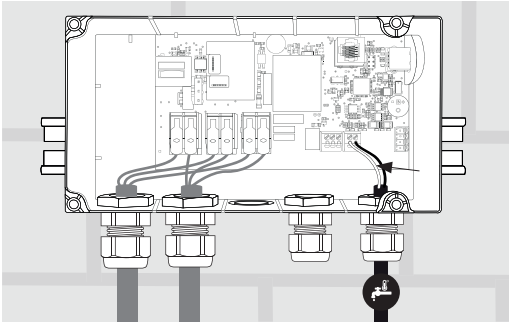

11

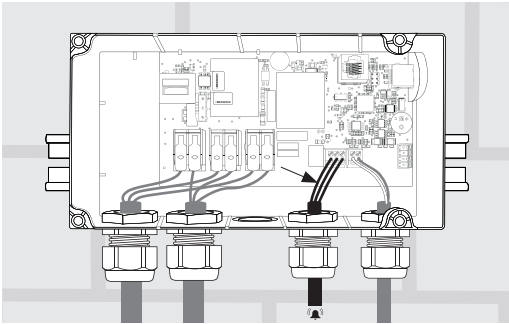

12

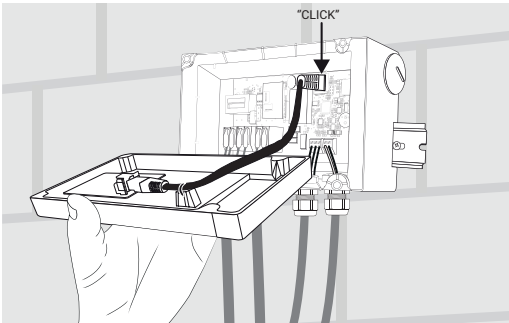

13

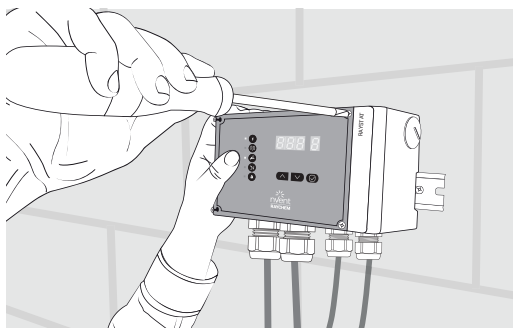

14.1

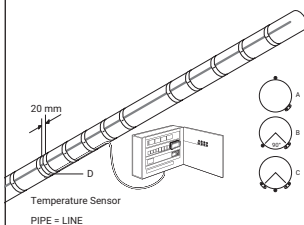

14.2



AIR = PASC

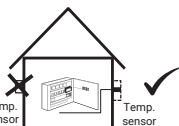

Temp. sensor

Temp. sensor

15

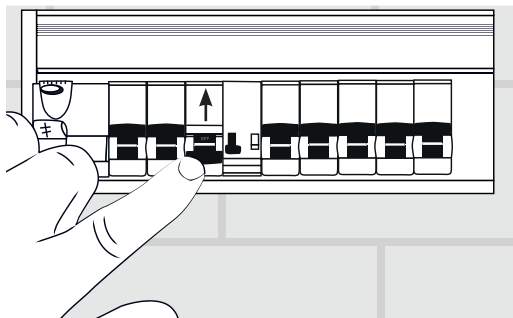

RCD / FI 30 mA - C 20 A : ON

QUICK START ➔ 64

## 1.3 INSTALLATION NOTES

The installation and, if necessary, the maintenance and the disassembling must be carried out by a qualified electrical installer.

The installation must be compatible with local regulations.

Check the maximum circuit length for your circuit breaker in the next table:

### Maximum circuit length at 230 VAC and for 5°C start-up temperature C-characteristic circuit breaker

Multiple units on multiple power points can be used if longer heating cables are required. We recommend to use nVent RAYCHEM SBS-FP-xx16A panels to operate 3, 6, 9 or 12 heating circuits

	10XL2-LH	15XL2-LH	26XL2-LH	31XL2-LH
Circuit breaker	(Plum)	(Green)	(Blue)	(Purple)
<b>C 10A</b>	128 m	96 m	73 m	57 m
<b>C 13A</b>	166 m	125 m	94 m	74 m
<b>C 16A</b>	204 m	153 m	116 m	91 m
<b>C 20A</b>	238 m	188 m	142 m	114 m

The nVent RAYCHEM Raystat V5 has a removable top lid. Both top and bottom of the box have electronic parts and are connected to each other by an Ethernet connector cable. The unit is delivered with top lid and back part dismantled.

**Warning:** For over voltage protection (e.g. in case of thunderstorm) we recommend the use of an external over voltage protection device.

### Care and maintenance

Clean the Raystat V5 with a soft damp cloth only, do not use any solvents. Do not pour water directly on the device. Do not use a water hose or a high pressure cleaner. Avoid installing the controller in rooms with high humidity and condensation. To operate the user interface, it must be clean and dry. For outdoor installation it will be recommended to use a sun & rain cover.

## Description

nVent RAYCHEM Raystat V5 is an electronic control thermostat with display, advanced alarm facilities and the capability of switching large currents (25 A). The Raystat V5 is designed to control nVent heating cable systems. Heating cable can be controlled (switched ON/OFF) either directly by the Raystat V5 or via a contactor.

Direct switching of heating cables is possible for heating loads up to 25 A. For heating loads above 25 A indirect switching via a suitably rated contactor controlled by a Raystat V5 is necessary.

Installation and all wiring must be in accordance with applicable regulations. The device must be installed in non hazardous areas only. nVent offers other controls for use in hazardous areas.

 The sensor must be installed. Attention: The sensor position on pipe or in Air needs to match the operation mode PiPE or Air. (PASC / ambient temperature measurement control). A wrong assignment can led to a frozen pipe. An alarm terminal makes remote signalling of errors possible. During commissioning of the unit it is recommend to simulate sensor functionality in PIPE sensing mode, since the AIR/PASC mode is not suitable for this test due to delay in the PASC algorithm. The unit can be pre-programmed in power-off mode by external power bank (to be ordered separately) connected via A-A-USB cable and USB connection.

## Technical data

<b>Product application</b>	nVent RAYCHEM Pipe freeze protection heating cables only
<b>Electrical properties</b>	
Supply voltage	180-253 VAC; 50/60Hz
Power consumption	5,3 W max
Power output relay (heating cable)	25 A / 230 VAC
Power supply terminals	3 x 6 mm <sup>2</sup> max
Heating cable terminals	3 x 6 mm <sup>2</sup> max



Alarm terminals	3 x 1,5 mm <sup>2</sup> max
Sensor terminal - Pipe	2 x 1,5 mm <sup>2</sup> max
Alarm relay	Single pole double throw relay, volt-free; Max. switching capacity (resistive load only) 1 A/30 VDC 0.5 A/125 VAC, Max.: 60 VDC/ 125 VAC
Settings	All settings are stored in non-volatile memory
Operating temperature	-40°C to +40°C ambient
Selectable temperature	PiPE: 0°C ... +90°C (PT 100 Sensor Module: -40°C ... +250°C: SM-PT100-1; PCN: 1244-022441) Air (PASC): 0°C ... +30°C
<b>Enclosure</b>	
Material	Polycarbonate
Dimensions	210 mm x 90 mm x 85 mm
Ingress protection class	IP 65
Weight	990 g
Mounting	DIN-Rail mountable 35 mm
Entries	2 x M25 and 2 x M20
Storage temperature	-40°C to +50°C
Flammability class	D category (DIN EN 60730/VDE 0631-1)
<b>Standard Sensor (included in the box)</b>	
Temperature sensor type	Standard NTC 2,0 kOhm at 25°C, 2 wires
Sensor tip dimensions	Ø 5 mm; length 20 mm
Sensor cable length	5 m; extendable up to 150 m , 2 x1,5 mm <sup>2</sup>
Temperature range	-40°C to +90°C

Sensor data	Temperature	Resistance in kOhm
	-40°C	32,34
	-35°C	24,96
	-30°C	19,48
	-25°C	15,29
	-20°C	12,11
	-15°C	9,655
	-10°C	7,763
	-5°C	6,277
	0°C	5,114
	+5°C	4,188
	+10°C	3,454
	+15°C	2,862
	+20°C	2,387
	+30°C	1,684
	+40°C	1,211
	+50°C	0,8854
	+60°C	0,6587
	+70°C	0,4975
	+80°C	0,3807
Approval	CE/UKCA mark; EMC According to EN 50081-1/2 for emission and EN50082 - 1/2 for immunity Temperature for ball pressure +100°C test (DIN EN 60730/VDE 0631-1) Rated impulse voltage: Overvoltage category III (DIN EN 60730/ VDE 0631-1)	

## Sensor installation for higher temperature ranges:

For higher temperature ranges up to 250°C a PT100 type of sensor can be connected by using the sensor-Plug-In Module SM-PT-100-1 (PCN: 1244-022441). A reset of the unit is needed to recognize this new hardware module and to activate the new temperature range.

Sensor			
	Standard	With SM-PT100-1 Module	
	(included in box)	HARD-78	MONI-PT100-260/2
Temperature sensor type	NTC 2 KOhm / 25°C, 2-wire	PT100	PT100
Sensor tip dimensions	Ø 5 mm, length 20 mm	Ø 6 mm, length 50 mm	Ø 6 mm, length 50 mm
Sensor cable length	5 m	3 m	2 m
Cable extension	Up to 150 m, min. 2 x 1,5 mm <sup>2</sup>	Up to 150 m, 3 x 1,5 mm <sup>2</sup>	Up to 150 m, 3 x 1,5 mm <sup>2</sup>
Temperature range	-40°C to +90°C	-40°C to +150°C	-50°C to +260°C

## OPERATION

The Raystat V5 has a LED user screen interface: The unit will switch to the main screen after 2 minutes of non-interaction on the parameter input screens.

## Quick install

When the unit is powered up for the first time, a quick setup must be executed before the unit is ready to start. The Quick start helps to set all important settings, the unit will go in main screen mode automatically when done. Quick start is sufficient for normal operations. More settings are available in the Setup menu for special installation conditions.

The Quick start will only start if no pre-setting is done.

**QUICK START** ➡ 64

**PARAMETER SETTING** ➡ 71

## Parameter overview :

PARAMETER	Operation Mode: PiPE	Operation Mode: Air = PASC	Description	Factory settings	Parameters
SP1	✓	✓	SET Temperature	+3°C	0°C ... +90°C
SP2	✓	✓	Operation mode selection	---	PiPE / Air
SP3		✓	Lowest ambient temperature	-20°C	-30°C ... 0°C
SP4		✓	Average pipe diameter level	2 >= DN 25 / 1"	01 = Ø < DN 25 / 1" 02 = Ø ≥ DN 25 / 1" 03 = Ø ≥ DN 50 / 2"
SP5	✓	✓	Heater operation in sensor failure mode	ON	ON/OFF
SP6	✓	✓	Heater operation via external contactor	No	Yes/No
SP7	✓		Hysteresis	1 K	0 K ... 5 K
SP8	✓		Low temperature alarm	0°C	OFF/-40°C
SP9	✓		Higher temperature alarm	+65°C	OFF/+65°C
SP10	✓	✓	Alarm sound status	ON	ON/OFF
SP11	✓	✓	TEST program	OFF	ON/OFF
SP12	✓	✓	KEY LOCK – Pass code	OFF	OFF/code 036
SP13	✓	✓	RESET	000	Code 012

## Error codes :

Error Code	Error description	Remedy
Er 2.1	Sensor open	1. Check sensor cable connection 2. Verify operation of unit 3. Replace unit if cable ok & error still exists
Er 2.2	Sensor short	1. Check sensor connection 2. Replace sensor 3. Replace unit if sensor ok & error still exists
Er 3.1	High temperature alarm	1. Verify heating system and sensor position 2. Verify menu settings of high temperature alarm
Er 4.1	Low temperature alarm	1. Verify heating system and sensor position 2. Verify menu settings of low temperature alarm
Er 6.x	Internal error	Replace unit

Error codes will be displayed after a time delay of 10 min.

## 1.3 INSTALLATIONSHINWEISE

Die Installation und, sofern erforderlich, die Wartung und das Öffnen der Einheit müssen von einer Elektrofachkraft vorgenommen werden. Daneben muss die Installation die örtlichen Bestimmungen erfüllen.

Ermitteln Sie die maximale Heizkreislänge für den von Ihnen verwendeten Leitungsschutzschalter anhand der nachstehenden Tabelle :

**Leitungsschutzschalter (C-Charakteristik) bei einer maximalen Heizkreislänge und 230 V AC sowie einer Einschalttemperatur von 5°C.**

Sofern größere Heizkreislängen erforderlich sind, müssen mehrere Einheiten mit jeweils eigener Stromversorgung verwendet werden. Wir empfehlen die Verwendung von Schaltschränken des Typs nVent RAYCHEM SBS-FP-xx16A, um 3, 6 oder 9 Heizkreise zu betreiben.

	10XL2-LH	15XL2-LH	26XL2-LH	31XL2-LH
Schutzschalter	(braun)	(grün)	(blau)	(violett)
<b>C 10A</b>	128 m	96 m	73 m	57 m
<b>C 13A</b>	166 m	125 m	94 m	74 m
<b>C 16A</b>	204 m	153 m	116 m	91 m
<b>C 20A</b>	238 m	188 m	142 m	114 m

Der nVent RAYCHEM Raystat V5 hat ein abnehmbares Oberteil. Das Oberteil und das Unterteil des Gehäuses enthalten elektronische Bauteile und sind über ein Ethernet-Kabel miteinander verbunden. Bei Auslieferung sind Ober- und Rückteil demontiert.

**Achtung:** Als Überspannungsschutz (z. B. bei Gewitter) wird der Einsatz von externen Überspannungsschutzkomponenten empfohlen.

### Pflege und Wartung

Reinigen Sie das Gehäuse des RAYSTAT v5 mit einem weichen, leicht angefeuchteten Tuch und vermeiden Sie jegliche Lösungsmittel.

Vermeiden Sie, dass Wasser unmittelbar auf das Gerät gelangt. Verwenden Sie keinen Wasserschlauch oder ein Hochdruckreinigungsgerät! Vermeiden Sie die Installation des Reglers in Räumen mit zu hoher Luftfeuchtigkeit und Kondensation. Die zu bedienende Benutzeroberfläche muss sauber und trocken sein. Für die Installation im Freien ist es empfohlen, eine Sonnen- und Regenschutzabdeckung zu verwenden und eine direkte Sonneneinstrahlung zu vermeiden.

## Beschreibung

nVent RAYCHEM Raystat V5 ist ein elektronischer Regelthermostat mit Anzeige, fortschrittlichen Alarmrichtungen und der Möglichkeit, große Ströme (25 A) zu schalten. Der Raystat V5 wurde zur Steuerung von nVent Begleitheizungssystemen entwickelt. Das Heizband kann entweder direkt vom Raystat V5 oder über ein Schütz gesteuert (EIN/AUS geschaltet) werden.

Für Heizlasten bis 25 A ist ein direktes Schalten der Heizbänder möglich.

Bei Heizlasten mit über 25 A Schaltstrom ist eine indirekte Schaltung über ein geeignetes, von einem Raystat V5 gesteuertes Schütz erforderlich.

Die Installation und alle Verkabelungen müssen den geltenden Vorschriften entsprechen.

Das Gerät darf nur in nicht explosionsgefährdeten Bereichen installiert werden. nVent bietet andere Steuerungen für den Einsatz in explosionsgefährdeten Bereichen.

 Der Sensor muss installiert werden. **Achtung: Die Sensorposition am Rohr oder in der Luft muss mit der Betriebsart PIPE oder Air. (PASC / Umgebungstemperatur übereinstimmen).** Eine falsche Zuordnung kann zu einem eingefrorenen Rohr führen. Eine Alarmklemme ermöglicht die Fernmeldung von Fehlern. Während der Inbetriebnahme des Geräts wird empfohlen, die Fühlerfunktion im PIPE-Fühlermodus zu simulieren, da der AIR/PASC-Modus aufgrund der Verzögerung im PASC-Algorithmus für diesen Test nicht geeignet ist. Der Raystat V5 kann im stromlosen Zustand vorprogrammiert werden durch Anschluss eines externen Charger/Batterie (z.Bsp. nVent RAYCHEM- PB Powerbank) über die USB-Schnittstelle.

## Technische Daten

<b>Produktanwendung</b>	Nur für nVent RAYCHEM Rohrleitungsfrostschutz Heizbänder
<b>Elektrische Daten</b>	
Betriebsspannung	230 VAC -15 /+10%; 50 Hz
Leistungsaufnahme	5,3 W max
Stromversorgungsrelais (Heizband)	25 A / 230 VAC

Anschlussklemmen	3 x 6 mm <sup>2</sup> max																																								
Heizbandklemmen	3 x 6 mm <sup>2</sup> max																																								
Alarmerklemmen	3 x 1,5 mm <sup>2</sup> max																																								
Fühlerklemme - Rohrleitung / Umgebungstemperatur	2 x 1,5 mm <sup>2</sup> max																																								
Alarmrelais	Einpoliger, potenzialfreier Wechselschalter Spannungsfrei; Max. Schaltkapazität 1 A/30 VDC 0.5 A/125 VAC, Max.: 60 VDC/125 VAC																																								
Einstellungen	Alle Einstellungen werden in einem nichtflüchtigen Speicher abgelegt																																								
Betriebstemperatur	-40°C bis +40°C																																								
Einstellbare Haltetemperatur	PiPE: 0°C bis +90°C (PT 100 Sensor Module: -40°C ... +250°C: SM-PT100-1; PCN: 1244-022441) Air (PASC): 0°C bis +30°C																																								
<b>Gehäuse</b>																																									
Material	Polycarbonat																																								
Maße	210 mm x 90 mm x 85 mm																																								
Schutzart	IP 65																																								
Gewicht	990 g																																								
Montage	Montage auf DIN-Schiene (35 mm)																																								
Kabelverschraubung	2 x M25 und 2 x M20																																								
Lagertemperatur	-40°C bis +50°C																																								
Entflammbarkeitsklasse	Kategorie D (DIN EN 60730/VDE 0631-1)																																								
<b>Fühler (mitgeliefert)</b>																																									
Temperaturfühler-Typ	Standard NTC 2,0 kOhm bei 25°C, zweiadrig																																								
Maße Fühlerspitze	Ø 5 mm; Länge 20 mm																																								
Fühlerkabellänge	5 m; verlängerbar auf 150 m, 2 x 1,5 mm <sup>2</sup>																																								
Temperaturbereich	-40°C bis +90°C																																								
Fühlerdaten	<table border="1" style="margin-left: auto; margin-right: auto;"> <thead> <tr> <th>Temperatur</th> <th>Widerstand in kΩ</th> </tr> </thead> <tbody> <tr><td>-40°C</td><td>32,34</td></tr> <tr><td>-35°C</td><td>24,96</td></tr> <tr><td>-30°C</td><td>19,48</td></tr> <tr><td>-25°C</td><td>15,29</td></tr> <tr><td>-20°C</td><td>12,11</td></tr> <tr><td>-15°C</td><td>9,655</td></tr> <tr><td>-10°C</td><td>7,763</td></tr> <tr><td>-5°C</td><td>6,277</td></tr> <tr><td>0°C</td><td>5,114</td></tr> <tr><td>+5°C</td><td>4,188</td></tr> <tr><td>+10°C</td><td>3,454</td></tr> <tr><td>+15°C</td><td>2,862</td></tr> <tr><td>+20°C</td><td>2,387</td></tr> <tr><td>+30°C</td><td>1,684</td></tr> <tr><td>+40°C</td><td>1,211</td></tr> <tr><td>+50°C</td><td>0,8854</td></tr> <tr><td>+60°C</td><td>0,6587</td></tr> <tr><td>+70°C</td><td>0,4975</td></tr> <tr><td>+80°C</td><td>0,3807</td></tr> </tbody> </table>	Temperatur	Widerstand in kΩ	-40°C	32,34	-35°C	24,96	-30°C	19,48	-25°C	15,29	-20°C	12,11	-15°C	9,655	-10°C	7,763	-5°C	6,277	0°C	5,114	+5°C	4,188	+10°C	3,454	+15°C	2,862	+20°C	2,387	+30°C	1,684	+40°C	1,211	+50°C	0,8854	+60°C	0,6587	+70°C	0,4975	+80°C	0,3807
Temperatur	Widerstand in kΩ																																								
-40°C	32,34																																								
-35°C	24,96																																								
-30°C	19,48																																								
-25°C	15,29																																								
-20°C	12,11																																								
-15°C	9,655																																								
-10°C	7,763																																								
-5°C	6,277																																								
0°C	5,114																																								
+5°C	4,188																																								
+10°C	3,454																																								
+15°C	2,862																																								
+20°C	2,387																																								
+30°C	1,684																																								
+40°C	1,211																																								
+50°C	0,8854																																								
+60°C	0,6587																																								
+70°C	0,4975																																								
+80°C	0,3807																																								
Zulassungen	CE; gemäß EN 60730 EMV gemäß EN 50081-1/2 für Störaussendungen und EN 50082-1/2 für Störfestigkeit Temperatur für Kugeldruckprüfung: +100°C (DIN EN 60730/VDE 0631-1) Bemessungsstoßspannung: Kategorie III (DIN EN 60730/VDE 0631-1)																																								

## Fühlerinstallation für höhere Temperaturbereiche:

Für höhere Temperaturbereiche bis 250°C kann ein Fühler vom Typ PT100 mit dem Fühler-Steckmodul SM-PT-100-1 (PCN: 1244-022441) angeschlossen werden. Um dieses neue Hardwaremodul zu erkennen und den neuen Temperaturbereich zu aktivieren, ist ein Reset des Gerätes erforderlich.

Fühler	Standard	Mit Fühler-Steckmodul SM-PT100-1	
	(In Lieferung enthalten)	HARD-78	MONI-PT100-260/2
Fühler Typ	NTC 2 KOhm / 25°C, 2-Draht	PT100	PT100
Fühlerelement Abmessungen	Ø 5 mm, Länge 20 mm	Ø 6 mm, Länge 50 mm	Ø 6 mm, Länge 50 mm
Fühlerkabel- Länge	5 m	3 m	2 m
Fühlerkabel - Verlängerung	Bis zu 150 m, min. 2 x 1,5 mm <sup>2</sup>	Bis zu 150 m, 3 x 1,5 mm <sup>2</sup>	Bis zu 150 m, 3 x 1,5 mm <sup>2</sup>
Temperatur-Bereich	-40°C bis +90°C	-40°C bis +150°C	-50°C bis +260°C

## BETRIEB

Der Raystat V5 wird über einen LED Screen mit 3 Eingabetasten bedient. Ist die LED-Anzeige für die Parametereingabe geöffnet, wechselt dieser nach 2 Minuten Inaktivität zum Hauptbildschirm zurück.

## Schnellinbetriebnahme

Bei der Erstinbetriebnahme des Temperaturstellers muss zuerst eine Schnellinbetriebnahme vorgenommen werden, bevor das System betriebsbereit ist. Diese Schnellinbetriebnahme unterstützt Sie bei allen wichtigen Einstellungen. Nach deren Beendigung wechselt der Temperatursteller automatisch zum Hauptbildschirm. Für den Normalbetrieb ist eine Schnellinbetriebnahme in der Regel ausreichend. Für spezifischere Installationen können weitere Einstellungen im Parameter-Menü vorgenommen werden.

Die Schnellinbetriebnahme startet nur, wenn keine Voreinstellung vorgenommen wurde.

**QUICK START ➡ 64**

**PARAMETER EINSTELLUNGEN ➡ 71**

## Parameterübersicht :

Sollwert-PARAMETER	Betriebsart: Anlegefühler PiPE	Betriebsart: Umgebungstemperatur Air = PASC	Beschreibung	Werks-einstellungen	Parameter
SP1	✓	✓	Sollwert Temperatur	+3°C	0°C ... +90°C
SP2	✓	✓	Betriebsart auswählen	----	PiPE / Air
SP3		✓	Sollwert für niedrigste Umgebungstemperatur	-20°C	-30°C ... 0°C
SP4		✓	Durchschnittlicher Rohrlängendurchmesser	2 >= DN 25 / 1"	01 = Ø < DN 25 / 1" 02 = Ø ≥ DN 25 / 1" 03 = Ø ≥ DN 50 / 2"
SP5	✓	✓	Heizungsstatus im Fühler-Fehlerfall	ON	ON/OFF
SP6	✓	✓	Steuerung über externen Schaltschütz	No	Yes/No
SP7	✓		Hysterese	1 K	0 K ... 5 K
SP8	✓		Sollwert Untertemperaturalarm	0°C	OFF/-40°C
SP9	✓		Sollwert Übertemperaturalarm	+65°C	OFF/+65°C
SP10	✓	✓	Alarmton status	ON	ON/OFF
SP11	✓	✓	Testprogramm	OFF	ON/OFF
SP12	✓	✓	Tastensperre	OFF	OFF/code 036
SP13	✓	✓	RESET	000	Code 012

## Fehler Codes :

Fehler Code	Fehlerbeschreibung	Fehlerbehebung
Er 2.1	Fühler offen	<ol style="list-style-type: none"> <li>1. Fühleranschlüsse überprüfen</li> <li>2. Fühlerwerte überprüfen</li> <li>3. Steuergerät ersetzen, wenn Fühler in Ordnung ist und Fehler weiterhin angezeigt wird</li> </ol>
Er 2.2	Fühler Kurzschluss	<ol style="list-style-type: none"> <li>1. Fühleranschlüsse überprüfen</li> <li>2. Fühlerwerte überprüfen</li> <li>3. Steuergerät ersetzen, wenn Fühler in Ordnung ist und Fehler weiterhin angezeigt wird</li> </ol>
Er 3.1	Übertemperatur Alarm	<ol style="list-style-type: none"> <li>1. Überprüfung des Begleitheizsystems und der Fühlerposition</li> <li>2. Überprüfe der Sollwerteinstellungen für Übertemperaturalarm</li> </ol>
Er 4.1	Untertemperatur Alarm	<ol style="list-style-type: none"> <li>1. Überprüfung des Begleitheizsystems und der Fühlerposition</li> <li>2. Überprüfe der Sollwerteinstellungen für Untertemperaturalarm</li> </ol>
Er 6.x	Interner Fehler	Steuergerät austauschen

Fehlercodes werden nach einer Zeitverzögerung von 10 min angezeigt.

## 1.3 CONSIGNES D'INSTALLATION

L'installation et, le cas échéant, l'entretien et le démontage du produit doivent être confiés à un électricien qualifié.

L'installation doit être conforme aux réglementations locales.

Vérifier la longueur maximale de circuit appropriée au disjoncteur de votre circuit dans le tableau suivant :

**Longueur maximale du circuit pour une tension de 230 V c.a. et une température de démarrage de 5°C**

**Disjoncteur courbe « C »**

Si des longueurs de ruban chauffant supérieures sont nécessaires, plusieurs points d'alimentations séparés seront nécessaires. Nous recommandons l'utilisation d'armoires nVent RAYCHEM SBS-FP-xx16A nVent pour exploiter 3, 6, 9 ou 12 circuits de chauffage.

	10XL2-LH	15XL2-LH	26XL2-LH	31XL2-LH
Disjoncteur	(Prune)	(Vert)	(Bleu)	(Violet)
<b>C 10A</b>	128 m	96 m	73 m	57 m
<b>C 13A</b>	166 m	125 m	94 m	74 m
<b>C 16A</b>	204 m	153 m	116 m	91 m
<b>C 20A</b>	238 m	188 m	142 m	114 m

L'unité nVent RAYCHEM Raystat V5 nVent est équipée d'un couvercle amovible. Les parties supérieure et inférieure du boîtier abritent des composants électroniques et sont interconnectées au moyen d'un câble de connecteur Ethernet. L'unité est livrée avec la partie arrière et le couvercle supérieur démontés.

**Attention :** pour la protection contre les surtensions (p. ex., en cas de foudre), nous recommandons l'utilisation d'un système de protection contre les surtensions externes.

### Entretien et maintenance

Nettoyer l'unité Raystat V5 à l'aide d'un chiffon doux humide. Ne pas utiliser de solvants. Ne pas asperger l'unité. Ne pas nettoyer à la lance d'arrosage ou au nettoyeur à haute pression. Évitez d'installer le contrôleur dans des pièces à forte humidité et condensation. Pour pouvoir utiliser l'interface utilisateur, celle-ci doit être propre et sèche. Pour une installation à l'extérieur, il sera recommandé d'utiliser une protection contre le soleil et la pluie.

## Description

Le modèle nVent RAYCHEM Raystat V5 nVent est un thermostat de régulation électronique comportant un écran, des fonctionnalités d'alarme avancées et une capacité de commutation de courants importants (25 A). Le modèle Raystat V5 est conçu pour réguler les systèmes de rubans chauffants nVent. La mise sous tension et hors tension des rubans chauffants se fait par le biais de l'unité Raystat V5 ou d'un contacteur.

La commutation directe des rubans chauffants est possible avec des charges de chauffage jusqu'à 25 A. Pour les charges de chauffage supérieures à 25 A, une commutation indirecte via un contacteur aux valeurs nominales appropriées contrôlé par un régulateur Raystat V5 est nécessaire.

L'installation et tout le câblage doivent être conformes aux réglementations en vigueur. Le dispositif doit être installé dans des zones non explosives uniquement. nVent propose d'autres régulateurs spécifiquement conçus pour les zones ATEX.



La sonde doit être installée. Attention : La position de la sonde sur le tuyau ou en ambiant doit correspondre au mode de fonctionnement PIPE ou Air. (PASC / contrôle de la mesure de la température ambiante). Une mauvaise attribution peut conduire au gel de canalisations.

Grâce à un report d'alarme, les erreurs peuvent être lues à distance. Lors de la mise en service de l'unité, il est recommandé de simuler la fonctionnalité du capteur en mode de détection PIPE, car le mode AIR/PASC n'est pas adapté à ce test en raison du retard de l'algorithme PASC. L'unité peut être préprogrammée en mode Hors tension à l'aide d'un bloc d'alimentation externe (à commander séparément) raccordé via un câble USB A-A et une connexion USB.

## Caractéristiques techniques

<b>Application cible du produit</b>	Rubans chauffants de mise hors gel des canalisations RAYCHEM nVent uniquement
<b>Caractéristiques électriques</b>	
Tension d'alimentation	180 à 253 V c.a. ; 50/60 Hz
Consommation électrique	5,3 W max



Relais puissance de sortie (ruban)	25 A / 230 V c.a.																																								
Bornes d'alimentation	3 x 6 mm <sup>2</sup> max.																																								
Bornes de ruban chauffant	3 x 6 mm <sup>2</sup> max.																																								
Bornes d'alarme	3 x 1,5 mm <sup>2</sup> max.																																								
Borne de sonde - tuyau	2 x 1,5 mm <sup>2</sup> max.																																								
Relais d'alarme	Relais SPDT, sans tension ; capacité de commutation max. (charge résistive uniquement) 1 A/30 V c.c., 0,5 A/125 V c.a., max. : 60 V c.c./125 V c.a.																																								
Réglages	Stockage de tous les paramètres en mémoire non volatile																																								
Température de service	-40°C à +40°C (ambiante)																																								
Température paramétrable	PiPE: 0°C à +90°C (PT 100 Sensor Module: -40°C ... +250°C: SM-PT100-1; PCN: 1244-022441) Air (PASC): 0°C à +30°C																																								
<b>Boîtier</b>																																									
Matériau	Polycarbonate																																								
Dimensions	210 x 90 x 85 mm																																								
Classe d'étanchéité	IP 65																																								
Poids	990 g																																								
Montage	Montage sur rail DIN 35 mm																																								
Entrées	2 entrées M25 et 2 entrées M20																																								
Température de stockage	-40°C à +50°C																																								
Catégorie d'inflammabilité	Catégorie D (DIN EN 60730/VDE 0631-1)																																								
<b>Sonde standard (inclus dans la boîte)</b>																																									
Type de sonde de température	CTN standard 2,0 kOhm à 25°C, 2 fils																																								
Dimensions du bulbe de la sonde	Ø 5 mm ; longueur 20 mm																																								
Longueur du câble de la sonde	5 m ; extensible à 150 m, 2 x 1,5 mm <sup>2</sup>																																								
Plage de températures	-40°C à +90°C																																								
Données de la sonde	<table border="1"> <thead> <tr> <th>Température</th> <th>Résistance en kOhm</th> </tr> </thead> <tbody> <tr><td>-40°C</td><td>32,34</td></tr> <tr><td>-35°C</td><td>24,96</td></tr> <tr><td>-30°C</td><td>19,48</td></tr> <tr><td>-25°C</td><td>15,29</td></tr> <tr><td>-20°C</td><td>12,11</td></tr> <tr><td>-15°C</td><td>9,655</td></tr> <tr><td>-10°C</td><td>7,763</td></tr> <tr><td>-5°C</td><td>6,277</td></tr> <tr><td>0°C</td><td>5,114</td></tr> <tr><td>+5°C</td><td>4,188</td></tr> <tr><td>+10°C</td><td>3,454</td></tr> <tr><td>+15°C</td><td>2,862</td></tr> <tr><td>+20°C</td><td>2,387</td></tr> <tr><td>+30°C</td><td>1,684</td></tr> <tr><td>+40°C</td><td>1,211</td></tr> <tr><td>+50°C</td><td>0,8854</td></tr> <tr><td>+60°C</td><td>0,6587</td></tr> <tr><td>+70°C</td><td>0,4975</td></tr> <tr><td>+80°C</td><td>0,3807</td></tr> </tbody> </table>	Température	Résistance en kOhm	-40°C	32,34	-35°C	24,96	-30°C	19,48	-25°C	15,29	-20°C	12,11	-15°C	9,655	-10°C	7,763	-5°C	6,277	0°C	5,114	+5°C	4,188	+10°C	3,454	+15°C	2,862	+20°C	2,387	+30°C	1,684	+40°C	1,211	+50°C	0,8854	+60°C	0,6587	+70°C	0,4975	+80°C	0,3807
Température	Résistance en kOhm																																								
-40°C	32,34																																								
-35°C	24,96																																								
-30°C	19,48																																								
-25°C	15,29																																								
-20°C	12,11																																								
-15°C	9,655																																								
-10°C	7,763																																								
-5°C	6,277																																								
0°C	5,114																																								
+5°C	4,188																																								
+10°C	3,454																																								
+15°C	2,862																																								
+20°C	2,387																																								
+30°C	1,684																																								
+40°C	1,211																																								
+50°C	0,8854																																								
+60°C	0,6587																																								
+70°C	0,4975																																								
+80°C	0,3807																																								

Agrément	Marque CE; selon les normes CEM, EN 50081-1/2 en matière d'émission et EN50082 - 1/2 en matière d'immunité ; température d'essai de boule à pression Test +100°C (DIN EN 60730/VDE 0631-1) Tension nominale de crête : Catégorie de surtension III (DIN EN 60730/VDE 0631-1)
----------	---

## Installation du sonde pour des plages de température plus élevées :

Pour des plages de température plus élevées, jusqu'à 250°C, un détecteur de type PT100 peut être connecté en utilisant le module SM-PT-100-1 (PCN : 1244-022441). Une réinitialisation de l'unité est nécessaire pour reconnaître ce nouveau module matériel et activer la nouvelle plage de température.

Sonde			
	Standard	Avec module SM-PT100-1	
	(inclus dans la boîte)	HARD-78	MO-NI-PT100-260/2
Type de sonde de température	NTC 2 KOhm / 25°C, 2-fils	PT100	PT100
Dimensions du bulbe de la sonde	Ø 5 mm, longueur 20 mm	Ø 6 mm, longueur 50 mm	Ø 6 mm, longueur 50 mm
Longueur du câble de la sonde	5 m	3 m	2 m
Rallonge de câble	Rallonge de 150 m, min. 2 x 1,5 mm <sup>2</sup>	Rallonge de 150 m, 3 x 1,5 mm <sup>2</sup>	Rallonge de 150 m, 3 x 1,5 mm <sup>2</sup>
Plage de températures	-40°C à +90°C	-40°C à +150°C	-50°C à +260°C

## FONCTIONNEMENT

L'unité Raystat V5 possède une interface utilisateur affichée sur un écran à LED : l'unité bascule sur l'écran principal après 2 minutes de non-interaction avec les écrans de saisie des paramètres.

### Paramétrage rapide (Quick install)

À la première mise sous tension de l'unité, procéder à un paramétrage rapide pour que l'unité puisse démarrer. Le paramétrage rapide permet de définir tous les paramètres importants. L'unité passera automatiquement en mode d'écran principal une fois l'opération terminée. Le paramétrage rapide est suffisant pour exécuter les opérations normales. Pour les installations plus complexes, d'autres options peuvent être sélectionnées dans le menu Réglage (Setup).

Le paramétrage rapide démarrera uniquement si aucun pré-réglage n'a été effectué.

**PARAMÉTRAGE RAPIDE ➡ 64**

**RÉGLAGES DES PARAMÈTRES ➡ 71**

## Présentation des paramètres :

PARA-MÈTRE	Mode de fonctionnement : PiPE	Mode de fonctionnement : Air = PASC	Description	Paramètres usine	Paramètres
SP1	✓	✓	Température de CONSIGNE	+3°C	0°C ... +90°C
SP2	✓	✓	Sélection du mode de fonctionnement	----	PiPE / Air
SP3		✓	Température ambiante minimale	-20°C	-30°C ... 0°C
SP4		✓	Niveau de diamètre moyen du tuyau	2 ≥ DN 25/1 po	01 = Ø < DN 25 / 1" 02 = Ø ≥ DN 25 / 1" 03 = Ø ≥ DN 50 / 2"
SP5	✓	✓	Fonctionnement du chauffage en mode Échec de la sonde	ON	ON/OFF
SP6	✓	✓	Fonctionnement du chauffage via un contacteur externe	No	Yes/No
SP7	✓		Hystérésis	1 K	0 K ... 5 K
SP8	✓		Alarme de température basse	0°C	OFF/-40°C
SP9	✓		Alarme de température haute	+65°C	OFF/+65°C
SP10	✓	✓	État de l'alarme sonore	ON	ON/OFF
SP11	✓	✓	Programme TEST	OFF	ON/OFF
SP12	✓	✓	VERROUILLAGE - saisir le code	OFF	OFF/code 036
SP13	✓	✓	RESET	000	Code 012

## Codes d'erreur :

Code d'erreur	Description de l'erreur	Solution
Er 2.1	Circuit ouvert sonde	1. Vérifier le raccordement du câble de la sonde 2. Vérifier le fonctionnement de l'unité 3. Remplacez l'unité si le câble est ok et que l'erreur persiste
Er 2.2	Court-circuit de la sonde	1. Vérifier le raccordement de la sonde 2. Vérifier le fonctionnement de la sonde et remplacer la sonde si nécessaire 3. Remplacer l'unité si la sonde est ok et que l'erreur persiste
Er 3.1	Alarme de température haute	1. Vérifier le système de traçage et la position de la sonde. 2. Vérifier les paramètres du menu de l'alarme de température haute
Er 4.1	Alarme de température basse	1. Vérifier le système de traçage et la position de la sonde. 2. Vérifier les paramètres du menu de l'alarme de température basse
Er 6.x	Erreur interne	Remplacer l'unité.

Les codes d'erreur s'affichent après un délai de 10 minutes.

## 1.3 INSTALLATIONSANMÄRKNINGAR

Installationen, och underhåll och demontering om nödvändigt, måste utföras av en kvalificerad elinstallatör.

Installationen måste följa lokala bestämmelser.

Kontrollera den maximala kretslängden för din automatsäkring i nästa tabell:

### Max. kretslängd vid 230 VAC och 5°C starttemperatur

#### Automatsäkring med C-karakteristik

Flera enheter på flera strömmattningspunkter kan användas om längre värmekablar krävs. Vi rekommenderar att använda panel nVent RAYCHEM SBS-FP-xx16A för att driva 3, 6, 9 eller 12 värmekretsar

	10XL2-LH	15XL2-LH	26XL2-LH	31XL2-LH
Automatsäkring	(Mörklila)	(Grön)	(Blå)	(Lila)
<b>C 10 A</b>	128 m	96 m	73 m	57 m
<b>C 13 A</b>	166 m	125 m	94 m	74 m
<b>C 16 A</b>	204 m	153 m	116 m	91 m
<b>C 20 A</b>	238 m	188 m	142 m	114 m

nVent RAYCHEM Raystat V5 har ett löstagbart topplock. Både överdelen och underdelen av kopplingsdosan har elektroniska delar som är anslutna till varandra med en Ethernet-kabel. Enheten levereras med topplocket och den bakre delen demonterade.

**Varning:** För överspänningsskydd (t.ex. vid åska) rekommenderar vi att använda ett externt överspänningsskydd.

#### Skötsel och underhåll

Rengör Raystat V5 endast med en mjuk, fuktig duk. Använd inga lösningsmedel. Häll inte vatten direkt på enheten. Använd inte vattenslang eller högtryckstvätt.

Undvik att installera kontrollenheten i rum med hög luftfuktighet och kondens. För att kunna göra inställningar måste manöverpanelen vara ren och torr. För installationer utomhus rekommenderas ett sol- och regnskydd.

## Beskrivning

nVent RAYCHEM Raystat V5 är en elektronisk reglertermostat med display, avancerade larmfunktioner och kapacitet att koppla höga strömmar (25 A). Raystat V5 är utformad för att reglera nVent värmekabelsystem. Värmekabeln kan regleras (kopplas PÅ/AV) antingen direkt av Raystat V5 eller via en kontaktor.

Direkt omkoppling av värmekablar är möjlig för värmelaster upp till 25 A. För värmelaster över 25 A är indirekt omkoppling via a kontaktor med lämplig klassning, reglerad av Raystat V5, nödvändig.

Installation och all ledningsdragnings måste utföras enligt tillämpliga bestämmelser. Enheten får endast installeras i ordinära miljöer. nVent erbjuder andra styrenheter för användning i farliga miljöer.

 Givaren måste vara installerad. Notera att givarplaceringen på rör eller i luft måste matcha driftläge PIPE eller AIR (PASC/reglering mot omgivningstemperatur). Fel inställning kan leda till fruset rör. Larm är kopplat till plint och gör det möjligt med fjärlarm. Under driftsättning av enheten rekommenderas att simulera givarfunktion i givarläge PIPE, eftersom givarläge AIR/PASC inte är lämplig då det är fördröjning i PASC algoritmen. Enheten kan programmeras utan spänning med en extern power bank (beställs separat) ansluten via A-A-USB kabel och USB uttaget.

## Tekniska data

<b>Produkttillämpning</b>	nVent RAYCHEM - Endast värmekablar för frostskydd av rörledningar
<b>Elektriska egenskaper</b>	
Matarspänning	180-253 VAC, 50/60 Hz
Effektförbrukning	5,3 W max.
Uteffekt relä (värmekabel)	25 A / 230 VAC
Plintar strömförsörjning	3 x 6 mm <sup>2</sup> max.
Värmekabelplintar	3 x 6 mm <sup>2</sup> max.
Larmplintar	3 x 1,5 mm <sup>2</sup> max.
Givarplint - Rör	2 x 1,5 mm <sup>2</sup> max.

Larmrelä	Enpoligt "double throw"-relä, spänningslöst. Max. brytkapacitet (endast resistiv last) 1 A/30 VDC, 0,5 A/125 VAC. Max: 60 VDC/ 125 VAC																																									
Inställningar	Alla inställningar lagras i ett icke-flyktigt minne																																									
Drifttemperatur	-40°C till +40°C omgivning																																									
Valbar temperatur	PiPE: 0°C till +90°C (PT 100 Sensor Module: -40°C ... +250°C: SM-PT100-1; PCN: 1244-022441) Air (PASC): 0°C till +30°C																																									
<b>Kapslingsklass</b>																																										
Material	Polykarbonat																																									
Mått	210 x 90 x 85 mm																																									
Kapslingsklass	IP 65																																									
Vikt	990 g																																									
Montering	Monterbar på DIN-skena, 35 mm																																									
Ingångar	2 x M25 och 2 x M20																																									
Förvaringstemperatur	-40 till +50°C																																									
Brandklassificering	Kategori D (DIN EN 60730/VDE 0631-1)																																									
<b>Standardgivare (medföljer i förpackningen)</b>																																										
Temperaturgivartyp	Standard NTC 2,0 kohm vid 25°C, 2 ledare																																									
Mått givarspets	Ø 5 mm, längd 20 mm																																									
Givarens kabellängd	5 m, förlängningsbar upp till 150 m, 2 x 1,5 mm <sup>2</sup>																																									
Temperaturområde	-40 till +90°C																																									
Givardata	<table border="1"> <thead> <tr> <th>Temperatur</th> <th>Resistans i kohm</th> </tr> </thead> <tbody> <tr><td>-40°C</td><td>32,34</td></tr> <tr><td>-35°C</td><td>24,96</td></tr> <tr><td>-30°C</td><td>19,48</td></tr> <tr><td>-25°C</td><td>15,29</td></tr> <tr><td>-20°C</td><td>12,11</td></tr> <tr><td>-15°C</td><td>9,655</td></tr> <tr><td>-10°C</td><td>7,763</td></tr> <tr><td>-5°C</td><td>6,277</td></tr> <tr><td>0°C</td><td>5,114</td></tr> <tr><td>+5°C</td><td>4,188</td></tr> <tr><td>+10°C</td><td>3,454</td></tr> <tr><td>+15°C</td><td>2,862</td></tr> <tr><td>+20°C</td><td>2,387</td></tr> <tr><td>+30°C</td><td>1,684</td></tr> <tr><td>+40°C</td><td>1,211</td></tr> <tr><td>+50°C</td><td>0,8854</td></tr> <tr><td>+60°C</td><td>0,6587</td></tr> <tr><td>+70°C</td><td>0,4975</td></tr> <tr><td>+80°C</td><td>0,3807</td></tr> </tbody> </table>		Temperatur	Resistans i kohm	-40°C	32,34	-35°C	24,96	-30°C	19,48	-25°C	15,29	-20°C	12,11	-15°C	9,655	-10°C	7,763	-5°C	6,277	0°C	5,114	+5°C	4,188	+10°C	3,454	+15°C	2,862	+20°C	2,387	+30°C	1,684	+40°C	1,211	+50°C	0,8854	+60°C	0,6587	+70°C	0,4975	+80°C	0,3807
Temperatur	Resistans i kohm																																									
-40°C	32,34																																									
-35°C	24,96																																									
-30°C	19,48																																									
-25°C	15,29																																									
-20°C	12,11																																									
-15°C	9,655																																									
-10°C	7,763																																									
-5°C	6,277																																									
0°C	5,114																																									
+5°C	4,188																																									
+10°C	3,454																																									
+15°C	2,862																																									
+20°C	2,387																																									
+30°C	1,684																																									
+40°C	1,211																																									
+50°C	0,8854																																									
+60°C	0,6587																																									
+70°C	0,4975																																									
+80°C	0,3807																																									
Godkännande	CE märkning; EMC enligt EN 50081-1/2 för strålning och EN50082 - 1/2 för immunitet Temperatur för kultryck 100°C test (DIN EN 60730/VDE 0631-1) Nominell impulsspänning: Överspänning kategori III (DIN EN 60730/ VDE 0631-1)																																									

## Installation av givare för högre temperaturer:

För högre temperaturer upp till 250°C kan en PT100 givare anslutas med hjälp av givarmodulen SM-PT-100-1 (PCN:1244-022441). En återställning av enheten är nödvändig för att den ska hitta denna ny hårdvara och aktivera det nya temperaturområdet.

Givare			
	Standard	Med modulen SM-PT100-1	
	medföljer låda	HARD-78	MONI-PT100-260/2
Typ av temperaturgivare	NTC 2 kOhm/ 25°C, 2-tråd	PT100	PT100
Dimension givarspets	Ø 5 mm, längd 20 mm	Ø 6 mm, längd 50 mm	Ø 6 mm, längd 50 mm
Längd givarkabel	5 m	3 m	2 m
Kabelförläggning	Upp till 150 m, min. 2 x 1,5 mm <sup>2</sup>	Upp till 150 m, 3 x 1,5 mm <sup>2</sup>	Upp till 150 m, 3 x 1,5 mm <sup>2</sup>
Temperaturområde	-40°C till +90°C	-40°C till +150°C	-50°C till +260°C

## DRIFT

Raystat V5 har en LED-skärm som användargränssnitt:

Enheten växlar till huvudskärmen efter 2 minuters inaktivitet på skärmarna för parameterinmatning.

## Snabbinstallation

När enheten sätts på första gången måste en snabbställning göras innan enheten är redo att starta. Snabbstarten hjälper till att göra alla viktiga inställningar. Enheten går därefter automatiskt in i huvudskärmsläge. Snabbstarten är tillräcklig för normal drift. Fler inställningar är tillgängliga på Inställningsmenyn för speciella installationsförhållanden.

Snabbstarten startar endast om ingen förinställning har gjorts.

**QUICK START ➡ 64**

**PARAMETERINSTÄLLNINGAR ➡ 71**

## Parameteröversikt:

PARAMETER	Driftläge: PIPE	Driftläge: Air = PASC	Beskrivning	Fabriksin- ställning	Parametrarna
SP1	✓	✓	INSTÄLLD temperatur	+3°C	0°C ... +90°C
SP2	✓	✓	Val av driftläge	----	PIPE / Air
SP3		✓	Lägsta omgivningstemperatur	-20°C	-30°C ... 0°C
SP4		✓	Genomsnittlig rördiameternivå	$\begin{matrix} 2 \\ \geq \text{DN } 25 \\ / 1'' \end{matrix}$	01 = $\emptyset < \text{DN } 25 / 1''$ 02 = $\emptyset \geq \text{DN } 25 / 1''$ 03 = $\emptyset \geq \text{DN } 50 / 2''$
SP5	✓	✓	Värmarfunktion i givar-felläge	ON	ON/OFF
SP6	✓	✓	Värmarfunktion via extern kontaktor	No	Yes/No
SP7	✓		Hysteres	1 K	0 K ... 5 K
SP8	✓		Larm låg temperatur	0°C	OFF/-40°C
SP9	✓		Larm hög temperatur	+65°C	OFF/+65°C
SP10	✓	✓	Status larmljud	ON	ON/OFF
SP11	✓	✓	TEST-program	OFF	ON/OFF
SP12	✓	✓	TANGENTLÅS - Passerkod	OFF	OFF/code 036
SP13	✓	✓	Återställning	000	Kod 012

## Felkoder:

Felkod	Felbeskrivning	Åtgärd
Er 2.1	Givare öppen	1. Kontrollera givarkabelns anslutning 2. Verifiera enhetens funktion 3. Byt ut enhet om kabel är ok och felet kvarstår
Er 2.2	Givare kortsluten	1. Kontrollera givaranslutning 2. Byt ut givare 3. Byt ut enhet om givare är ok och felet kvarstår
Er 3.1	Larm hög temperatur	1. Verifiera värmesystem och givarplacering 2. Verifiera menyinställningar och larm hög temperatur
Er 4.1	Larm låg temperatur	1. Verifiera värmesystem och givarplacering 2. Verifiera menyinställningar och larm låg temperatur
Er 6.x	Internt fel	Byt ut enhet

Felkoder visas efter 10 minuters fördröjning.

## 1.3 INSTALLASJONSMANUAL

Installasjon, og om nødvendig, vedlikehold og demontering skal utføres av kvalifisert elektroinstallatør.

Installasjonen skal oppfylle lokale normer/krav.

Kontroller maksimal varmekabellengde for automatsikringen i tabellen nedenfor:

### Maksimal varmekabellengde ved 230 VAC og for 5°C oppstartstemperatur – automatsikring med C-karakteristikk

Flere enheter på flere tilkoblingspunkter kan brukes om det trengs lengre varmekabler. Vi anbefaler å bruke nVent RAYCHEM SBS-FP-xx16A-paneler for å betjene 3, 6, 9 eller 12 varmekabellengder.

	10XL2-LH	15XL2-LH	26XL2-LH	31XL2-LH
Automatsikring	(Lilla)	(Grønn)	(Blå)	(Fiolett)
<b>C 10 A</b>	128 m	96 m	73 m	57 m
<b>C 13 A</b>	166 m	125 m	94 m	74 m
<b>C 16 A</b>	204 m	153 m	116 m	91 m
<b>C 20 A</b>	238 m	188 m	142 m	114 m

nVent RAYCHEM Raystat V5 har avtakbart topplokk. Både toppen og bunnen av boksen har elektroniske deler og er koblet sammen med en Ethernet-kabel. Enheten leveres med topplokk og bakdel demontert.

**Advarsel:** For å beskytte mot overspenning (f.eks. i tilfelle tordenvær) anbefaler vi å bruke et eksternt overspenningsvern.

### Pleie og vedlikehold

Rengjør Raystat V5 kun med fuktig, myk klut, ikke bruk løsemidler. Ikke hell vann rett på enheten. Ikke spyl med vannslange eller høytrykksvasker. Unngå å installere kontrolleren i rom med høy luftfuktighet og kondens. Til å betjene brukergrensesnittet, må det være rent og tørt. For utendørs installasjon vil det anbefales og beskytte mot sol- og regn.

## Beskrivelse

nVent RAYCHEM Raystat V5 er en elektronisk styretermostat med display, avanserte alarmsystemer og evne til å koble store strømmer (25 A). Raystat V5 er konstruert for å styre nVent-varmekabelsystemer. Varmekablene kan styres (slå AV/PÅ) enten direkte av Raystat V5 eller via en kontaktor.

Direkte kobling av varmekabler er mulig for varmebelastninger opp til 25 A. For belastninger over 25 A er det nødvendig med kobling via en egnet kontaktor som styres av en Raystat V5.

Installasjonen og all kablingen må utføres i henhold til gjeldende forskrifter/normer. Enheten skal kun installeres i ufarlige områder. nVent tilbyr andre styringer for bruk i farlige områder.

 Sensor må installeres. Obs! Sensorposisjonen på rør eller i luft må stemme med driftsmodus PiPE eller Air. (PASC / måling for omgivelsestemperatur). Feil driftsmodus kan føre til frosne rør. En alarmterminal gjør det mulig å fjernsignalisere feil. Enheten kan forhåndsprogrammeres i avslått modus av en eksternt strømbank (bestilles separat) som er tilkoblet via A-A-USB-kabel og USB-kontakt.

## Tekniske data

<b>Produktapplikasjon</b>	Kun nVent RAYCHEM varmekabler for frostsikring
<b>Elektriske egenskaper</b>	
Tilkoblingsspenning	180–253 VAC; 50/60 Hz
Strømforbruk	5,3 W maks
Utgangseffektrelé (varmekabel)	25 A/230 VAC
Strømforsyningsterminaler	3 x 6 mm <sup>2</sup> maks
Varmekabelterminaler	3 x 6 mm <sup>2</sup> maks
Alarmterminaler	3 x 1,5 mm <sup>2</sup> maks
Sensorterminal – rør	2 x 1,5 mm <sup>2</sup> maks



Alarmrelé	Énpolet NO/NC-relé, spenningsfri, maks. koblekapasitet (kun resistiv belastning) 1A/30 VDC 0,5 A/125 VAC, maks.: 60 VDC/125 VAC																																								
Innstillinger	Alle innstillinger lagres i ikke-flyktig minne																																								
Driftstemperatur	-40°C til +40°C omgivelsestemperatur																																								
Valgbar temperatur	PiPE: 0°C til +90°C (PT 100 Sensor Module: -40°C ... +250°C: SM-PT100-1; PCN: 1244-022441) Air (PASC): 0°C til +30°C																																								
<b>Kapsling</b>																																									
Materiale	Polykarbonat																																								
Mål	210 mm x 90 mm x 85 mm																																								
IP-grad	IP 65																																								
Vekt	990 g																																								
Montering	Kan monteres på DIN-skinne 35 mm																																								
Gjennomføringer	2 x M25 og 2 x M20																																								
Oppbevaringstemperatur	-40°C til +50°C																																								
Antennelsesklasse	D-kategori (DIN EN 60730/VDE 0631-1)																																								
<b>Standard Sensor (inkludert i boksen)</b>																																									
Temperatursensortype	Standard NTC 2,0 kOhm ved 25°C, 2 ledere																																								
Sensorende-dimensjoner	Ø 5 mm; lengde 20 mm																																								
Sensorkabellengde	5 m; kan forlenges opp til 150 m, 2 x 1,5 mm <sup>2</sup>																																								
Temperaturområde	-40°C til +90°C																																								
Sensordata	<table border="1" style="width: 100%; border-collapse: collapse; text-align: center;"> <thead> <tr> <th>Temperatur</th> <th>Motstand i kOhm</th> </tr> </thead> <tbody> <tr><td>-40°C</td><td>32,34</td></tr> <tr><td>-35°C</td><td>24,96</td></tr> <tr><td>-30°C</td><td>19,48</td></tr> <tr><td>-25°C</td><td>15,29</td></tr> <tr><td>-20°C</td><td>12,11</td></tr> <tr><td>-15°C</td><td>9,655</td></tr> <tr><td>-10°C</td><td>7,763</td></tr> <tr><td>-5°C</td><td>6,277</td></tr> <tr><td>0°C</td><td>5,114</td></tr> <tr><td>+5°C</td><td>4,188</td></tr> <tr><td>+10°C</td><td>3,454</td></tr> <tr><td>+15°C</td><td>2,862</td></tr> <tr><td>+20°C</td><td>2,387</td></tr> <tr><td>+30°C</td><td>1,684</td></tr> <tr><td>+40°C</td><td>1,211</td></tr> <tr><td>+50°C</td><td>0,8854</td></tr> <tr><td>+60°C</td><td>0,6587</td></tr> <tr><td>+70°C</td><td>0,4975</td></tr> <tr><td>+80°C</td><td>0,3807</td></tr> </tbody> </table>	Temperatur	Motstand i kOhm	-40°C	32,34	-35°C	24,96	-30°C	19,48	-25°C	15,29	-20°C	12,11	-15°C	9,655	-10°C	7,763	-5°C	6,277	0°C	5,114	+5°C	4,188	+10°C	3,454	+15°C	2,862	+20°C	2,387	+30°C	1,684	+40°C	1,211	+50°C	0,8854	+60°C	0,6587	+70°C	0,4975	+80°C	0,3807
Temperatur	Motstand i kOhm																																								
-40°C	32,34																																								
-35°C	24,96																																								
-30°C	19,48																																								
-25°C	15,29																																								
-20°C	12,11																																								
-15°C	9,655																																								
-10°C	7,763																																								
-5°C	6,277																																								
0°C	5,114																																								
+5°C	4,188																																								
+10°C	3,454																																								
+15°C	2,862																																								
+20°C	2,387																																								
+30°C	1,684																																								
+40°C	1,211																																								
+50°C	0,8854																																								
+60°C	0,6587																																								
+70°C	0,4975																																								
+80°C	0,3807																																								
Godkjenning	CE-merke; EMC i henhold til EN 50081-1/2 for utslipp og EN50082 - 1/2 for immunitet Temperatur for kuletrykk + 100°C test (DIN EN 60730 / VDE 0631-1) Nominell impulsspenning: Overspenningskategori III (DIN EN 60730 / VDE 0631-1)																																								

## Sensorinstallasjon for høyere temperaturområder:

For høyere temperaturområder opptil 250°C kan en PT100-føler kobles til ved hjelp av sensor-plug-in-modul SM-PT-100-1 (PCN: 1244-022441). En tilbakestilling av enheten er nødvendig for å gjenkjenne denne nye maskinvaremodulen og for å aktivere det nye temperaturområdet.

Sensor /føler	Standard	Med SM-PT100-1 modul	
	(inkludert i boksen)	HARD-78	MONI-PT100-260/2
Temperaturføler type	NTC 2 KOhm / 25°C, 2-leder	PT100	PT100
Føler tupp dimensjon	Ø 5 mm, lengde 20 mm	Ø 6 mm, lengde 50 mm	Ø 6 mm, lengde 50 mm
Føler kabel lengde	5 m	3 m	2 m
Kabelforlengelse	Opp til 150 m, min. 2 x 1,5 mm <sup>2</sup>	Opp til 150 m, 3 x 1,5 mm <sup>2</sup>	Opp til 150 m, 3 x 1,5 mm <sup>2</sup>
Temperaturspenn	-40°C til +90°C	-40°C til +150°C	-50°C til +260°C

## DRIFT

Raystat V5 har brukergrensesnitt med LED-skjerm:

Enheden endrer til hovedskjermbildet etter 2 minutter uten aktivitet i parameterskjermbildene.

## Hurtiginstallering

Når du slår på enheten for første gang, må du gjennomføre et raskt oppsett før enheten er klar for start. Hurtigstarten bidrar til å gjennomføre alle viktige innstillinger. Enheden går deretter automatisk over til hovedskjermmodus. Hurtigstart er tilstrekkelig for vanlig drift. Flere innstillinger er tilgjengelige i oppsettmenyen for spesielle installasjonsforhold.

Hurtigstarten starter kun dersom det ikke er utført forhåndsinnstillinger.

**QUICK START ➡ 64**

**PARAMETER SETTING ➡ 71**

## Parameteroversikt:

PARAMETER	Driftsmodus: PiPE (rør-føler)	Driftsmodus: Air = PASC (omgivelsestemperatur)	Beskrivelse	Fabrikkinnstillinger	Parameterne
SP1	✓	✓	SET-temperatur	+3°C	0°C ... +90°C
SP2	✓	✓	Valg av driftsmodus	----	PiPE / Air
SP3		✓	Laveste omgivelsestemperatur	-20°C	-30°C ... 0°C
SP4		✓	Gjennomsnittlig rørdiameternivå	2 >= DN 25/1"	01 = Ø < DN 25 / 1" 02 = Ø ≥ DN 25 / 1" 03 = Ø ≥ DN 50 / 2"
SP5	✓	✓	Varmedrift i sensor-feilmodus	ON	ON/OFF
SP6	✓	✓	Drift via ekstern kontaktor	No	Yes/No
SP7	✓		Hysteres	1 K	0 K ... 5 K
SP8	✓		Alarm for lav temperatur	0°C	OFF/-40°C
SP9	✓		Alarm for overtemperatur.	+65°C	OFF/+65°C
SP10	✓	✓	Alarmlydstatus	ON	ON/OFF
SP11	✓	✓	Testprogram	OFF	ON/OFF
SP12	✓	✓	TASTELÅS – adgangskode	OFF	OFF/code 036
SP13	✓	✓	RESET	000	Code 012

## Feilkoder:

Feilkode	Feilbeskrivelse	Utbedring
Er 2.1	Sensor åpen	1. Kontroller sensortilkoblingen 2. Verifiser at enheten er i drift 3. Skift ut enheten om kabelen er OK og feilen fortsetter
Er 2.2	Sensorkortslutning	1. Kontroller sensortilkoblingen 2. Skift ut sensoren 3. Skift ut enheten om sensoren er OK og feilen fortsetter
Er 3.1	Alarm for høy temperatur	1. Verifiser varmesystem og sensorposisjon 2. Verifiser menyinnstillinger for høy temperatur-alarmer
Er 4.1	Alarm for lav temperatur	1. Verifiser varmesystem og sensorposisjon 2. Verifiser menyinnstillinger for lav temperatur-alarmer
Er 6.x	Intern feil	Skift ut enheten

Feilkoder vises etter en tidsforsinkelse på 10 minutter.

## 1.3 ASENNUSTA KOSKEVAT HUOMAUTUKSET

Termostaatin asentaminen ja tarvittaessa huoltamisen ja/tai purkamisen saa suorittaa vain sähköalan ammattihenkilö, jolla on riittävä pätevyysluokitus. Asennus tulee suorittaa paikallisten määräysten mukaisesti.

Tarkasta vikavirtasuojakytkimen taakse asennettavan piirin enimmäispituus seuraavasta taulukosta:

**Piirin enimmäispituus jännitteellä 230 VAC, kytkentälämpötilassa 5 °C, C-tyypin johdonsuoja-automaatti**

Pitkät putket/putkistot kannattaa jakaa useampaan lyhyempään piiriin. Suosittelemme käyttämään 3, 6, 9 tai 12 lämmityspiiriin nVent RAYCHEM SBS-FP-xx16A -ohjauskeskuksia.

	10XL2-LH	15XL2-LH	26XL2-LH	31XL2-LH
Johdonsuoja-automaatti	(Luumu)	(Vihreä)	(Sininen)	(Violetti)
<b>C 10 A</b>	128 m	96 m	73 m	57 m
<b>C 13 A</b>	166 m	125 m	94 m	74 m
<b>C 16 A</b>	204 m	153 m	116 m	91 m
<b>C 20 A</b>	238 m	188 m	142 m	114 m

nVent RAYCHEM Raystat V5 -ohjaimessa on irrotettava kansi. Sekä ohjaimen kannessa että pohjaosassa on elektroniikkaosia, jotka on yhdistetty toisiinsa Ethernet-kaapelilla. Ohjaimen kansi- ja pohjaosa ovat toimitettaessa irrotettuina.

**Varoitus:** Suosittelemme käytettäväksi erillistä ulkoista ylijännitesuojaa (esim. ukkossuojaukseksi.) Ei sisälly toimitukseen.

### Huolto ja kunnossapito

Puhdista Raystat V5 pelkästään pehmeällä, kostealla liinalla. Älä käytä liuotinaiteita. Älä kaada vettä suoraan laitteen päälle. Älä käytä vesilettoa tai korkeapainepesuria. Vältä termostaatin asentamista huoneisiin jossa on paljon kosteutta tai kondensaatiota. Käyttöliittymän käyttämiseksi sen on oltava puhdas ja kuiva. Ulkoasennuksessa on suositeltavaa käyttää aurinko- ja sadesuojaa.

## Kuvaus

nVent RAYCHEM Raystat V5 on elektroninen ohjaustermostaatti, jossa on näyttö, edistyneet hälytystoiminnot ja suuri 25 A:n virrankestoisuus. Raystat V5 on suunniteltu erityisesti nVent RAYCHEM -lämpökaapelijärjestelmien ohjaamiseen. Lämpökaapelia voidaan ohjata (kytkentä PÄÄLLE/POIS) joko suoraan Raystat V5 -ohjaimella tai kontaktorin avulla.

Lämpökaapelit voidaan kytkeä suoraan enintään 25 A:n lämmityskuormaan asti. Yli 25 A:n lämmityskuormien epäsuora kytkentä tehdään oikein mitoitetuilla kontaktoreilla, joita Raystat V5 -ohjaustermostaatti ohjaa.

Asennusten ja kaikkien johtojen on oltava sovellettavien säädösten mukaiset. Laitetta EI saa asentaa räjähdysvaaralliselle alueelle. nVentiltä on saatavissa myös räjähdysvaarallisiin tiloihin soveltuvia ohjaimia.

**!** Anturin asentaminen on pakollista. Huomio: Varmista, että käytät oikeaa anturiasetusta: putki tai ulkoilma-anturi. Ohjaimen valitun toiminnon tulee vastata kyseistä putki- tai ilma asetusta. (PASC / ympäristön lämpötilan valvonta). Väärä anturin sijainti voi aiheuttaa putken jäämisen. Hälytysliitin mahdollistaa etähälytyksen. Termostaatin käyttöönoton aikana on suositeltavaa simuloida anturin toiminta putkitunnistustilassa, koska ILMA/PASC-tila ei sovellu tähän testiin PASC-algoritmin viivästymisen vuoksi. Yksikkö voidaan ohjelmoida virrattomassa tilassa ulkoisella virtalähteellä (tilattavissa erikseen), joka yhdistetään A-A-USB-kaapelilla ja USB-liitännällä.

## Tekniset tiedot

Tuotteen käyttökohde	nVent RAYCHEM – Putkien sulanapito lämmityskaapeleilla. Käytettäessä muita tarkista takuuehdot.
<b>Sähköominaisuudet</b>	
Syöttöjännite	180–253 VAC; 50/60 Hz
Tehonkulutus	Enintään 5,3 W
Lähtörele (lämpökaapeli)	25 A / 230 VAC
Virtalähteen liittimet	Enintään 3 x 6 mm <sup>2</sup>

Lämpökaapelin liittimet	Enintään 3 x 6 mm <sup>2</sup>																																								
Hälytysliittimet	Enintään 3 x 1,5 mm <sup>2</sup>																																								
Anturin liittimet – putki	Enintään 2 x 1,5 mm <sup>2</sup>																																								
Hälytysrele	Yksinapainen, kaksiasentoinen SPDT-rele, jännitevapaa, suurin kytkentäkapasiteetti (vain resistiivinen kuorma) 1 A/30 VDC 0,5 A/125 VAC, enint: 60 VDC/125 VAC																																								
Asetukset	Kaikki asetukset tallennetaan pysyvään muistiin.																																								
Toimintalämpötila	-40 °C...+40 °C, ympäristö																																								
Valittavissa oleva lämpötila-alue	PiPE: 0 °C ... +90 °C (PT 100 Sensor Module: -40 °C ... +250 °C: SM-PT100-1; Snro: 81 710 97) Air (PASC): 0 °C ... +30 °C																																								
<b>Kotelo</b>																																									
Materiaali	Polykarbonaatti																																								
Mitat	210 mm x 90 mm x 85 mm																																								
Suojausluokka	IP 65																																								
Paino	990 g																																								
Asennus	DIN-kisko 35 mm																																								
Läpiviennit	2 x M25 ja 2 x M20																																								
Varastointilämpötila	-40 °C...+50 °C																																								
Syttyvyysluokka	D-luokka (DIN EN 60730/VDE 0631-1)																																								
<b>Anturi (sisältyy pakkaukseen)</b>																																									
Lämpötila-anturin tyyppi	NTC 2,0 kOhm / 25 °C, 2-johtiminen																																								
Anturin kärjen mitat	Ø 5 mm; pituus 20 mm																																								
Anturikaapelin pituus	5 m; jatkettavissa 150 metriin, 2 x 1,5 mm <sup>2</sup>																																								
Lämpötila-alue	-40 °C...+90 °C																																								
Anturin tiedot	<table border="1"> <thead> <tr> <th>Lämpötila</th> <th>Vastusarvo, kOhm</th> </tr> </thead> <tbody> <tr><td>-40 °C</td><td>32,34</td></tr> <tr><td>-35 °C</td><td>24,96</td></tr> <tr><td>-30 °C</td><td>19,48</td></tr> <tr><td>-25 °C</td><td>15,29</td></tr> <tr><td>-20 °C</td><td>12,11</td></tr> <tr><td>-15 °C</td><td>9,655</td></tr> <tr><td>-10 °C</td><td>7,763</td></tr> <tr><td>-5 °C</td><td>6,277</td></tr> <tr><td>0 °C</td><td>5,114</td></tr> <tr><td>+5 °C</td><td>4,188</td></tr> <tr><td>+10 °C</td><td>3,454</td></tr> <tr><td>+15 °C</td><td>2,862</td></tr> <tr><td>+20 °C</td><td>2,387</td></tr> <tr><td>+30 °C</td><td>1,684</td></tr> <tr><td>+40 °C</td><td>1,211</td></tr> <tr><td>+50 °C</td><td>0,8854</td></tr> <tr><td>+60 °C</td><td>0,6587</td></tr> <tr><td>+70 °C</td><td>0,4975</td></tr> <tr><td>+80 °C</td><td>0,3807</td></tr> </tbody> </table>	Lämpötila	Vastusarvo, kOhm	-40 °C	32,34	-35 °C	24,96	-30 °C	19,48	-25 °C	15,29	-20 °C	12,11	-15 °C	9,655	-10 °C	7,763	-5 °C	6,277	0 °C	5,114	+5 °C	4,188	+10 °C	3,454	+15 °C	2,862	+20 °C	2,387	+30 °C	1,684	+40 °C	1,211	+50 °C	0,8854	+60 °C	0,6587	+70 °C	0,4975	+80 °C	0,3807
Lämpötila	Vastusarvo, kOhm																																								
-40 °C	32,34																																								
-35 °C	24,96																																								
-30 °C	19,48																																								
-25 °C	15,29																																								
-20 °C	12,11																																								
-15 °C	9,655																																								
-10 °C	7,763																																								
-5 °C	6,277																																								
0 °C	5,114																																								
+5 °C	4,188																																								
+10 °C	3,454																																								
+15 °C	2,862																																								
+20 °C	2,387																																								
+30 °C	1,684																																								
+40 °C	1,211																																								
+50 °C	0,8854																																								
+60 °C	0,6587																																								
+70 °C	0,4975																																								
+80 °C	0,3807																																								

Hyväksyntä	CE-merkki; EMC standardin EN 50081-1 / 2 mukaan päästöjen osalta ja EN50082 - 1/2 häiriösiedon osalta. Lämpötila pallopaine-kokeessa +100 °C. (DIN EN 60730 / VDE 0631-1) Nimellinen impulssijännite: Ylijänniteluokka III (DIN EN 60730 / VDE 0631-1)
------------	---

## Anturin asennus korkeammille lämpötila-alueille:

Korkeammille lämpötila-alueille 250 °C:seen saakka PT100-tyyppinen anturi voidaan kytkeä SM-PT-100-1 (Snro: 81 710 97) moduuliin. Termostaatti on palautettava tehdasasetuksiin, jotta tämä uusi laitteistomoduuli voidaan tunnistaa ja uusi lämpötila-alue voidaan aktivoida.

Anturi			
	Vakiovaruste	SM-PT100-1 moduulin kanssa	
	(sisältyy pakkaukseen)	HARD-78	MONI-PT100-260/2
Anturin tyyppi	NTC 2 KΩ / 25 °C, 2-johtiminen	PT100	PT100
Anturin ilmaispään mitat	Ø 5 mm, pituus 20 mm	Ø 6 mm, pituus 50 mm	Ø 6 mm, pituus 50 mm
Anturikaapelin pituus	5 m	3 m	2 m
Anturikaapelin jatkaminen	150 metriin saakka, kun käytetään 2 x 1,5 mm <sup>2</sup>	150 metriin saakka, 3 x 1,5 mm <sup>2</sup>	150 metriin saakka, 3 x 1,5 mm <sup>2</sup>
Lämpötila-alue	-40 °C to +90 °C	-40 °C to +150 °C	-50 °C to +260 °C

## TOIMINTA

Raystat V5 -ohjaimessa on LED-näytöllinen käyttöliittymä: ohjain siirtyy takaisin päänäyttöön, mikäli asetusten syöttäminen keskeytyy kahdeksi (2) minuutiksi.

## Pika-asennus

Ensimmäisellä käynnistyskerralla yksikölle on tehtävä pikakäyttöönotto, ennen kuin se on valmis käynnistymään. Pikakäyttöönotto auttaa määrittämään kaikki tärkeät asetukset. Yksikkö siirtyy tämän jälkeen päänäyttötilaan automaattisesti. Pikakäyttöönotto on riittävä normaalitoiminnoissa. Asetusvalikossa on lisäasetuksia erityistilanteita varten.

Pikakäyttöönotto toimii vain, jos esiasetuksia ei ole määritetty.

Parametrit voidaan muuttaa painamalla OK-painiketta 6 sekunnin ajan. Termostaatti voidaan suojata näppäinlukituksella. Jos tämä näppäinlukitus on aktiivinen, termostaatin lukitus on avattava oikealla koodilla. (Katso SP 12 parametriluettelossa.) Raystat V5:n tehdasasetukset palautetaan painamalla samanaikaisesti nuoli ylös-, nuoli alas- ja OK-painiketta 6 sekunnin ajan.

**PIKAKÄYTTÖÖNOTTO ➡ 64**

**PARAMETRIEN ASETUKSET ➡ 71**

## Parametrit:

PARAMETRI	Toimintatila: PiPE	Toimintatila: Air = PASC	Kuvaus	Tehdasasetukset	Parametrit
SP1	✓	✓	ASETETTU lämpötila	+3 °C	0 °C ... +90 °C
SP2	✓	✓	Toimintatilan valinta	----	PiPE / Air
SP3		✓	Ympäristön alin lämpötila	-20 °C	-30 °C ... 0 °C
SP4		✓	Putken keskiahkaisija	2 ≥ DN 25/1"	01 = Ø < DN 25 / 1" 02 = Ø ≥ DN 25 / 1" 03 = Ø ≥ DN 50 / 2"
SP5	✓	✓	Lämmityksen toiminta anturin vikaantuessa	ON	ON/OFF
SP6	✓	✓	Lämmityksen käyttö kontaktorin kautta	No	Yes/No
SP7	✓		Hystereesi	1 K	0 K ... 5 K
SP8	✓		Matalan lämpötilan hälytys	0 °C	OFF/-40 °C
SP9	✓		Korkean lämpötilan hälytys	+65 °C	OFF/+65 °C
SP10	✓	✓	Hälytysäänen tila	ON	ON/OFF
SP11	✓	✓	TESTI-ohjelma	OFF	ON/OFF
SP12	✓	✓	NÄPPÄINLUKKO – salasana	OFF	OFF/koodi 036
SP13	✓	✓	NOLLAUS	000	Koodi 012

## Vikakoodit:

Vika-koodi	Vian kuvaus	Korjaus
Er 2.1	Anturia ei kytketty	1. Tarkasta anturikaapelin kytkentä 2. Tarkista anturikaapeli 3. Vaihda yksikkö, jos anturikaapeli on kunnossa mutta vikatila jatkuu.
Er 2.2	Anturin oikosulku	1. Tarkista anturin liitäntä. 2. Vaihda anturi. 3. Vaihda yksikkö, jos anturi on kunnossa mutta vikatila jatkuu.
Er 3.1	Korkean lämpötilan hälytys	1. Tarkasta lämmitysjärjestelmä ja anturin sijainti. 2. Tarkasta valikon korkean lämpötilan hälytyksen asetukset.
Er 4.1	Matalan lämpötilan hälytys	1. Tarkasta lämmitysjärjestelmä ja anturin sijainti. 2. Tarkasta alhaisen lämpötilan hälytyksen asetukset.
Er 6.0	Sisäinen virhe	Vaihda yksikkö.

Mahdolliset vikakoodit näytetään 10 minuutin kuluttua.

## 1.3 INSTALLATIONS Bemærkninger

Installationen og om nødvendigt vedligeholdelsen og afmonteringen må kun udføres af en autoriseret elektriker.

Installationen skal være i overensstemmelse med lokale bestemmelser.

Kontroller hovedafbryderens maksimale kredsløbslængde i næste tabel:

**Maks. kredsløbslængde ved 230 V AC og ved en starttemperatur på 5°C**

**En hovedafbryder med C-egenskaber**

Hvis der kræves længere varmekabler kan der anvendes flere enheder. Vi anbefaler, at der anvendes nVent RAYCHEM SBS-FP-xx16A paneler til at betjene 3, 6, 9 eller 12 varmekredsløb

	10XL2-LH	15XL2-LH	26XL2-LH	31XL2-LH
Effektafbryder	<b>(Mørkerød)</b>	<b>(Grøn)</b>	<b>(Blå)</b>	<b>(Lilla)</b>
<b>C 10A</b>	128 m	96 m	73 m	57 m
<b>C 13A</b>	166 m	125 m	94 m	74 m
<b>C 16A</b>	204 m	153 m	116 m	91 m
<b>C 20A</b>	238 m	188 m	142 m	114 m

nVent RAYCHEM Raystat V5 er udstyret med et aftageligt toplåg. Toppen og bunden af kassen indeholder elektroniske dele, og de er forbundne med hinanden med en Ethernet-forbindelsesledning. Enheden leveres med afmonteret låg og bagplade.

**Advarsel:** Til overspændingsbeskyttelse (f.eks. ved tordenvej) anbefaler vi brug af en ekstern overspændingsbeskyttelsesenhed.

### Pleje og vedligeholdelse

Rengør kun Raystat V5 med en blød, fugtig klud, brug ikke opløsningsmidler. Hæld ikke vand direkte på enheden. Brug ikke en vandslange eller en højtryksrensers. Undgå at installere controlleren i rum med høj luftfugtighed og kondensering. For at kunne betjene brugergrænsefladen skal den være ren og tør. Ved udendørs installation anbefales det at bruge et sol- og regndæksel.

## Beskrivelse

nVent RAYCHEM Raystat V5 er en elektronisk styret termostat med et display, avancerede alarmfunktioner og evnen til at bryde store strømstyrker 25 (A). Raystat V5 er beregnet til at styre nVent-varmekabelsystemer. Varmekabler kan styres (slå til eller fra) enten direkte af Raystat V5 eller ved hjælp af et relæ.

Direkte tilslutning af varmekabler er mulig op til en belastning på 25 A. Ved belastninger over 25 A er det nødvendigt at anvende tilslutning via et relæ, der styres af Raystat V5.

Installationen og al ledningsføring skal være i overensstemmelse med gældende lovgivning. Enheden må kun installeres i almindelige områder. nVent tilbyder andre styreenheder til EX-områder.



Der skal installeres en sensor. Bemærk: Sensorens position på røret eller i luft skal matche PiPE eller Air. (PASC / kontrolmåling af omgivelsestemperatur). En forkert placering kan medføre, at røret fryser til.

En alarmterminal gør det muligt at fjernsignalere fejl. Under idriftsættelsen af enheden anbefales det at simulere sensorens funktionalitet i PIPE-følgstilstand, da AIR/PASC-tilstanden ikke er egnet til denne test på grund af forsinkelsen i PASC-algoritmen. Enheden kan programmeres i slukket tilstand af en ekstern powerbank (der bestilles separat), der er forbundet vha. en A-A-USB-ledning eller en USB-forbindelse.

## Tekniske specifikationer

<b>Produktanvendelse</b>	Kun til nVent RAYCHEM varmekabler til frostbeskyttelse af rør
<b>Elektriske egenskaber</b>	
Forsyningsspænding	180-253 V AC; 50/60 Hz
Strømforbrug	5,3 W maks
Udgangsrelæ (varmekabel)	25 A / 230 V AC
Strømforsyningsterminaler	3 x 6 mm <sup>2</sup> maks.
Varmekabelterminaler	3 x 6 mm <sup>2</sup> maks.
Alarmterminaler	3 x 1,5 mm <sup>2</sup> maks.



Sensorterminal - Rør	2 x 1,5 mm <sup>2</sup> maks.																																								
Alarmrelæ	1 pol, dobbelt bredde relæ, potentialfri, (kun modstandsbelastning) 1 A/30 V DC 0,5 A/125 V AC, maks.: 60 V DC/125 V AC																																								
Indstillinger	Alle indstillinger gemmes i et hukommelsesmodul																																								
Driftstemperatur	-40°C til +40°C omgivelsestemperatur																																								
Valgbar temperatur	PiPE: 0°C til +90°C (PT 100 Sensor Module: -40°C ... +250°C: SM-PT100-1; PCN: 1244-022441) Air (PASC): 0°C til +30°C																																								
<b>Kabinet</b>																																									
Materiale	Polykarbonat																																								
Mål	210 mm x 90 mm x 85 mm																																								
Beskyttelsesklasse	IP 65																																								
Vægt	990 g																																								
Montering	Monterbar på DIN-skinne 35 mm																																								
Indgange	2 x M25 og 2 x M20																																								
Opbevaringstemperatur	-40°C til +50°C																																								
Brændbarhedsklasse	Kategori D (DIN EN 60730/VDE 0631-1)																																								
<b>Standardsensor (medfølger i æsken)</b>																																									
Temperatursensortype	Standard NTC 2,0 kOhm ved 25°C, 2 tråde																																								
Sensorspidsens mål	Ø 5 mm, længde 20 mm																																								
Sensorkabellængde	5 m; udvides til op til 150 m, 2 x 1,5 mm <sup>2</sup>																																								
Temperaturområde	-40°C til +90°C																																								
Sensordata	<table border="1"> <thead> <tr> <th>Temperatur</th> <th>Modstand i kOhm</th> </tr> </thead> <tbody> <tr><td>-40°C</td><td>32,34</td></tr> <tr><td>-35°C</td><td>24,96</td></tr> <tr><td>-30°C</td><td>19,48</td></tr> <tr><td>-25°C</td><td>15,29</td></tr> <tr><td>-20°C</td><td>12,11</td></tr> <tr><td>-15°C</td><td>9,655</td></tr> <tr><td>-10°C</td><td>7,763</td></tr> <tr><td>-5°C</td><td>6,277</td></tr> <tr><td>0°C</td><td>5,114</td></tr> <tr><td>+5°C</td><td>4,188</td></tr> <tr><td>+10°C</td><td>3,454</td></tr> <tr><td>+15°C</td><td>2,862</td></tr> <tr><td>+20°C</td><td>2,387</td></tr> <tr><td>+30°C</td><td>1,684</td></tr> <tr><td>+40°C</td><td>1,211</td></tr> <tr><td>+50°C</td><td>0,8854</td></tr> <tr><td>+60°C</td><td>0,6587</td></tr> <tr><td>+70°C</td><td>0,4975</td></tr> <tr><td>+80°C</td><td>0,3807</td></tr> </tbody> </table>	Temperatur	Modstand i kOhm	-40°C	32,34	-35°C	24,96	-30°C	19,48	-25°C	15,29	-20°C	12,11	-15°C	9,655	-10°C	7,763	-5°C	6,277	0°C	5,114	+5°C	4,188	+10°C	3,454	+15°C	2,862	+20°C	2,387	+30°C	1,684	+40°C	1,211	+50°C	0,8854	+60°C	0,6587	+70°C	0,4975	+80°C	0,3807
Temperatur	Modstand i kOhm																																								
-40°C	32,34																																								
-35°C	24,96																																								
-30°C	19,48																																								
-25°C	15,29																																								
-20°C	12,11																																								
-15°C	9,655																																								
-10°C	7,763																																								
-5°C	6,277																																								
0°C	5,114																																								
+5°C	4,188																																								
+10°C	3,454																																								
+15°C	2,862																																								
+20°C	2,387																																								
+30°C	1,684																																								
+40°C	1,211																																								
+50°C	0,8854																																								
+60°C	0,6587																																								
+70°C	0,4975																																								
+80°C	0,3807																																								

Godkendelse	CE-mærkning. EMC i henhold til EN 50081-1/2 angående emission og EN50082-1/2 angående immunitetstemperatur for standard tryk +100°C-test (DIN EN 60730/VDE 0631-1) Mærkeimpulsspænding: Overspænding kategori III (DIN EN 60730/ VDE 0631-1)
-------------	---

## Sensorinstallation til højere temperaturintervaller:

For højere temperaturområder op til 250 °C kan der tilsluttes en PT100-sensor ved hjælp af sensor-plug-in-modulet SM-PT-100-1 (PCN: 1244-022441). En nulstilling af enheden er nødvendig for at genkende dette nye hardwaremodul og aktivere det nye temperaturområde.

Sensor			
	Standard	med SM-PT100-1 Modul	
	(medfølger i æsken)	HARD-78	MONI-PT100-260/2
Type temperatursensor	NTC 2 KOhm / 25°C, 2-Leder	PT100	PT100
Dimensioner på sensorspidsen	Ø 5 mm, længde 20 mm	Ø 6 mm, længde 50 mm	Ø 6 mm, længde 50 mm
Sensorkabellængde	5 m	3 m	2 m
Kabelforlængelse	Op til 150 m, min. 2 x 1,5 mm <sup>2</sup>	Op til 150 m, 3 x 1,5 mm <sup>2</sup>	Op til 150 m, 3 x 1,5 mm <sup>2</sup>
Temperaturområde	-40°C til +90°C	-40°C til +150°C	-50°C til +260°C

## BETJENING

Raystat V5 er udstyret med en brugergrænseflade med en LED-skærm:

Enheden skifter til hovedskærmen efter 2 minutters inaktivitet på skærmene til parameterindtastning.

## Hurtig installation

Første gang, der tændes for enheden, skal der udføres en hurtig installation, før enheden er klar til start. Hurtigstarten hjælper med at indstille alle de vigtigste indstillinger, og enheden går automatisk i skærmtilstand, når dette er gjort. Hurtigstarten er tilstrækkelig til almindelig drift. Der ses flere indstillinger i opsætningsmenuen for specielle indstillingsbetingelser.

Hurtigstarten starter kun, hvis der ikke er foretaget forudindstillinger.

**HURTIG START ➡ 64**

**PARAMETERINDSTILLING ➡ 71**

## Parameteroversigt:

PARAMETER	Betjeningstilstand: PIPE	Betjeningstilstand: Air = PASC	Beskrivelse	Fabrik-sindstillinger	Parametre
SP1	✓	✓	INDSTILLET temperatur	+3°C	0°C ... +90°C
SP2	✓	✓	Valg af betjeningstilstand	----	PIPE / Air
SP3		✓	Laveste omgivelsestemperatur	-20°C	-30°C ... 0°C
SP4		✓	Gennemsnitlig niveau af rørdiameter	2 ≥ DN 25 / 1"	01 = Ø < DN 25 / 1" 02 = Ø ≥ DN 25 / 1" 03 = Ø ≥ DN 50 / 2"
SP5	✓	✓	Betjening af varmeeenhed i tilstanden sensorfejl	ON	ON/OFF
SP6	✓	✓	Betjening af varmeeenheden vha. ekstern afbryder	No	Yes/No
SP7	✓		Hysterese	1 K	0 K ... 5 K
SP8	✓		Alarm for lav temperatur	0°C	OFF/-40°C
SP9	✓		Alarm for høj temperatur	+65°C	OFF/+65°C
SP10	✓	✓	Alarmlydsstatus	ON	ON/OFF
SP11	✓	✓	TEST-program	OFF	ON/OFF
SP12	✓	✓	Tasteturlås - Adgangskode	OFF	OFF/code 036
SP13	✓	✓	RESET	000	Code 012

## Fejlkoder:

Fejlkode	Fejlbeskrivelse	Løsning
Er 2.1	Sensor åben	1. Kontroller sensorledningens forbindelse 2. Kontroller enhedens funktion 3. Udskift enheden, hvis ledningen er ok, og fejlen stadig findes
Er 2.2	Sensor kortsluttet	1. Kontroller sensorforbindelsen 2. Udskift sensor 3. Udskift enheden, hvis sensoren er ok, og fejlen stadig findes
Er 3.1	Alarm for høj temperatur	1. Kontroller varmesystemets og sensorens position 2. Kontroller menuindstillingerne for alarmerne for høj temperatur
Er 4.1	Alarm for lav temperatur	1. Kontroller varmesystemets og sensorens position 2. Kontroller menuindstillingerne for alarmerne for lav temperatur
Er 6.0	Intern fejl	Udskift enheden

Fejlkoder vises efter en tidsforsinkelse på 10 minutter.

## 1.3 INSTALLATIEOPMERKINGEN

Installatie en, indien nodig, onderhoud en demontage van de eenheid moeten worden verricht door een gekwalificeerd monteur.

De installatie moet voldoen aan de plaatselijke voorschriften.

Controleer de maximale circuitlengte voor uw stroomonderbreker in de volgende tabel:

### Maximale circuitlengte bij 230 VAC en voor een opstarttemperatuur van 5°C C-curve stroomonderbreker.

Er kunnen meerdere eenheden op meerdere voedingspunten worden gebruikt als langere verwarmingskabels vereist zijn. We bevelen het gebruik van nVent RAYCHEM SBS-FP-xx16A-panelen aan voor de bediening van 3, 6, 9 of 12 verwarmingscircuits.

	10XL2-LH	15XL2-LH	26XL2-LH	31XL2-LH
Stroomonderbreker	<b>(Donkerrood)</b>	<b>(Groen)</b>	<b>(Blauw)</b>	<b>(Paars)</b>
<b>C 10A</b>	128 m	96 m	73 m	57 m
<b>C 13A</b>	166 m	125 m	94 m	74 m
<b>C 16A</b>	204 m	153 m	116 m	91 m
<b>C 20A</b>	238 m	188 m	142 m	114 m

De nVent RAYCHEM Raystat V5 heeft een afneembaar deksel. De boven- en onderkant van de doos bevatten elektronische onderdelen en zijn met elkaar verbonden via een Ethernet-verbindingkabel. De eenheid wordt geleverd met gedemonteerd bovendecksel en achterkant.

**Waarschuwing:** Voor overspanningsbeveiliging (bijv. in geval van onweer) raden we het gebruik van een externe overspanningsbeveiliging aan.

### Reiniging en onderhoud

Reinig de Raystat V5 uitsluitend met een zachte, vochtige doek. Gebruik geen oplosmiddelen. Giet geen water rechtstreeks op de regeleenheid. Gebruik geen waterslang of hogedrukreiniger. Vermijd de installatie van de regeleenheid op plaatsen met hoge vochtigheid en condensatie. Voor de bediening moet het voorpaneel van de regeleenheid zuiver en droog zijn. Voor een buiteninstallatie is een zonne- en regenkap aanbevolen.

## Beschrijving

nVent RAYCHEM Raystat V5 is een elektronische thermostaat met display, geavanceerde alarmfuncties en het vermogen om grote stromen te schakelen (25 A). De Raystat V5 is ontworpen voor de regeling van nVent verwarmingskabels. Verwarmingskabels kunnen ofwel direct door de Raystat V5 of via een vermogensrelais worden geregeld (AAN/UIT).

Voor belastingen tot 25 A kunnen verwarmingskabels direct worden geschakeld. Voor belastingen hoger dan 25 A moet indirect worden geschakeld via een geschikt vermogensrelais dat wordt aangestuurd door een Raystat V5.

De installatie en alle bedrading moeten voldoen aan de geldende voorschriften. Het apparaat mag alleen in niet-explosieve omgevingen worden geïnstalleerd. Voor explosie-gevaarlijke omgevingen biedt nVent andere regelaars.

 De sensor moet geïnstalleerd zijn. Opgelet: De sensorpositie op de leiding of in lucht moet overeenkomen met de bedrijfsmodus PiPE of Air. (PASC / regeling door meting van de omgevingstemperatuur). Door een verkeerde toewijzing kunnen leidingen bevriezen. Voor de ingebruikname van de eenheid is het aanbevolen om de sensorwerking te controleren in PiPE modus omdat de Air/PASC modus niet geschikt is voor testen vanwege de tijdsvertragingen in het PASC algoritme.

Met een alarmaansluiting kunnen fouten vanop afstand worden gesignaleerd. De eenheid kan door middel van een externe power bank (die apart moet worden besteld) die is aangesloten via een A-A-USB-kabel en USB-aansluiting, worden voorgeprogrammeerd in de uitstand.

## Technische gegevens

<b>Producttoepassing</b>	Alleen nVent RAYCHEM-verwarmingskabels voor vorstbeveiliging van leidingen
<b>Elektrische eigenschappen</b>	
Voedingsspanning	180-253 VAC; 50/60Hz
Stroomverbruik	Max. 5,3 W
Relais uitgangsvermogen (verwarmingskabel)	25 A / 230 VAC

Voedingsaansluitingen	Max. 3 x 6 mm <sup>2</sup>																																								
Verwarmingkabelaansluitingen	Max. 3 x 6 mm <sup>2</sup>																																								
Alarmaansluitingen	Max. 3 x 1,5 mm <sup>2</sup>																																								
Sensoraansluiting - Leiding	Max. 2 x 1,5 mm <sup>2</sup>																																								
Alarmrelais	Enkelpolig, twee standen, spanningsvrij; Max. schakelcapaciteit (alleen weerstandsbelasting) 1 A/30 VDC 0,5 A/125 VAC, Max.: 60 VDC/125 VAC																																								
Instellingen	Alle instellingen worden opgeslagen in een niet-vluchtig geheugen																																								
Bedrijfstemperatuur	-40°C tot +40°C omgevingstemperatuur																																								
Instelbare temperatuur	PiPE: 0°C tot +90°C (PT 100 Sensor Module: -40°C ... +250°C: SM-PT100-1; PCN: 1244-022441) Air (PASC): 0°C tot +30°C																																								
<b>Behuizing</b>																																									
Materiaal	Polycarbonaat																																								
Afmetingen	210 mm x 90 mm x 85 mm																																								
Bescherming tegen vochtintrede klasse	IP 65																																								
Gewicht	990 g																																								
Montage	35 mm DIN-rail																																								
Kabeldoorvoeren	2 x M25 en 2 x M20																																								
Opslagtemperatuur	-40°C tot +50°C																																								
Brandbaarheidsclassificatie	Categorie D (DIN EN 60730/VDE 0631-1)																																								
<b>Standaard Sensor (meegeleverd)</b>																																									
Type temperatuursensor	Standaard NTC 2,0 kΩ bij 25°C, 2-draads																																								
Afmetingen sensortip	Ø 5 mm; lengte 20 mm																																								
Lengte sensorkabel	5 m; verlengbaar tot 150 m, 2 x 1,5 mm <sup>2</sup>																																								
Temperatuurbereik	-40°C tot +90°C																																								
Sensorgegevens	<table border="1"> <thead> <tr> <th>Temperatuur</th> <th>Weerstand in kΩ</th> </tr> </thead> <tbody> <tr><td>-40°C</td><td>32,34</td></tr> <tr><td>-35°C</td><td>24,96</td></tr> <tr><td>-30°C</td><td>19,48</td></tr> <tr><td>-25°C</td><td>15,29</td></tr> <tr><td>-20°C</td><td>12,11</td></tr> <tr><td>-15°C</td><td>9,655</td></tr> <tr><td>-10°C</td><td>7,763</td></tr> <tr><td>-5°C</td><td>6,277</td></tr> <tr><td>0°C</td><td>5,114</td></tr> <tr><td>+5°C</td><td>4,188</td></tr> <tr><td>+10°C</td><td>3,454</td></tr> <tr><td>+15°C</td><td>2,862</td></tr> <tr><td>+20°C</td><td>2,387</td></tr> <tr><td>+30°C</td><td>1,684</td></tr> <tr><td>+40°C</td><td>1,211</td></tr> <tr><td>+50°C</td><td>0,8854</td></tr> <tr><td>+60°C</td><td>0,6587</td></tr> <tr><td>+70°C</td><td>0,4975</td></tr> <tr><td>+80°C</td><td>0,3807</td></tr> </tbody> </table>	Temperatuur	Weerstand in kΩ	-40°C	32,34	-35°C	24,96	-30°C	19,48	-25°C	15,29	-20°C	12,11	-15°C	9,655	-10°C	7,763	-5°C	6,277	0°C	5,114	+5°C	4,188	+10°C	3,454	+15°C	2,862	+20°C	2,387	+30°C	1,684	+40°C	1,211	+50°C	0,8854	+60°C	0,6587	+70°C	0,4975	+80°C	0,3807
Temperatuur	Weerstand in kΩ																																								
-40°C	32,34																																								
-35°C	24,96																																								
-30°C	19,48																																								
-25°C	15,29																																								
-20°C	12,11																																								
-15°C	9,655																																								
-10°C	7,763																																								
-5°C	6,277																																								
0°C	5,114																																								
+5°C	4,188																																								
+10°C	3,454																																								
+15°C	2,862																																								
+20°C	2,387																																								
+30°C	1,684																																								
+40°C	1,211																																								
+50°C	0,8854																																								
+60°C	0,6587																																								
+70°C	0,4975																																								
+80°C	0,3807																																								

Goedkeuring	CE: EMC conform EN 50081-1/2 voor emissies en EN50082 - 1/2 voor immuñiteit Temperatuur voor kogeldruk +100°C test (DIN EN 60730/VDE 0631-1) Nominale stootspanning: Overspanningscategorie III (DIN EN 60730/VDE 0631-1)
-------------	--

## Installatie van de sensor voor hogere temperaturen:

Voor een temperatuurbereik tot 250°C kan een PT100 sensor aangesloten worden met behulp van Plug-In module SM-PT100-1 (PCN: 1244-022441). Een reset van de eenheid is nodig opdat de nieuwe hardware-module erkend wordt en om het nieuwe temperatuurbereik te activeren.

Sensor	Standaard	met SM-PT100-1 Module	
	(meegeleverd)	HARD-78	MONI-PT100-260/2
Temperatuursensor type	NTC 2 KOhm / 25°C, 2-wire	PT100	PT100
Sensor tip afmetingen	Ø 5 mm, lengte 20 mm	Ø 6 mm, lengte 50 mm	Ø 6 mm, lengte 50 mm
Sensorkabel lengte	5 m	3 m	2 m
Kabelextentie	Tot 150 m, min. 2 x 1,5 mm <sup>2</sup>	Tot 150 m, 3 x 1,5 mm <sup>2</sup>	Tot 150 m, 3 x 1,5 mm <sup>2</sup>
Temperatuurbereik	-40°C to +90°C	-40°C to +150°C	-50°C to +260°C

## WERKING

De Raystat V5 heeft een bedieningspaneel met ledscherm:

De eenheid schakelt na 2 minuten inactiviteit in de instelschermen over naar het hoofdscherm.

## Snelle installatie

Wanneer de eenheid voor het eerst wordt aangezet, moeten een aantal snelle instellingen worden verricht, voordat de eenheid klaar is voor gebruik. De snelstart helpt u alle belangrijke instellingen uit te voeren. Na afloop gaat de eenheid automatisch naar het hoofdscherm. Voor normale toepassingen is een snelstart voldoende. Meer instellingen voor speciale installatie-omstandigheden zijn beschikbaar in het menu Setup (Instellingen).

De snelstart moet enkel doorlopen worden wanneer er geen voorinstellingen zijn gedaan.

**SNELSTART** ➔ 64

**PARAMETER INSTELLINGEN** ➔ 71

## Instellingenoverzicht:

PARAMETER	Bedrijfsmodus: PiPE	Bedrijfsmodus: Air = PASC	Beschrijving	Fabrieksinstellingen	Parameters
SP1	✓	✓	Insteltemperatuur	+3°C	0°C ... +90°C
SP2	✓	✓	Selectie bedrijfsmodus	----	PiPE / Air
SP3		✓	Laagste omgevingstemperatuur	-20°C	-30°C ... 0°C
SP4		✓	Gemiddelde leidingdiameter	2 ≥ DN 25 / 1"	01 = Ø < DN 25 / 1" 02 = Ø ≥ DN 25 / 1" 03 = Ø ≥ DN 50 / 2"
SP5	✓	✓	Werking verwarming in sensorfoutmodus	ON	ON/OFF
SP6	✓	✓	Werking verwarming via externe contactgever	No	Yes/No
SP7	✓		Hysterese	1 K	0 K ... 5 K
SP8	✓		Alarm bij lage temperatuur	0°C	OFF/-40°C
SP9	✓		Alarm bij hogere temperatuur	+65°C	OFF/+65°C
SP10	✓	✓	Alarmgeluid status	ON	ON/OFF
SP11	✓	✓	Testprogramma	OFF	ON/OFF
SP12	✓	✓	TOETSVERGREDELING - Toegangscode	OFF	OFF/code 036
SP13	✓	✓	RESET	000	Code 012

## Foutcodes:

Foutcode	Foutbeschrijving	Oplossing
Er 2.1	Onderbroken sensor	1. Controleer aansluiting sensorkabel 2. Controleer werking eenheid 3. Vervang eenheid als kabel in orde is en fout aanhoudt
Er 2.2	Kortsluiting sensor	1. Controleer aansluitingen sensor 2. Vervang sensor 3. Vervang eenheid als sensor in orde is en fout aanhoudt
Er 3.1	Alarm bij hoge temperatuur	1. Controleer verwarmingssysteem en sensorpositie 2. Controleer menu-instellingen van alarm bij hoge temperatuur
Er 4.1	Alarm bij lage temperatuur	1. Controleer verwarmingssysteem en sensorpositie 2. Controleer menu-instellingen van alarm bij lage temperatuur
Er 6.0	Interne fout	Vervang eenheid

Foutcodes verschijnen op het scherm met een tijdsvertraging van 10 min.

## 1.3 UWAGI DOTYCZĄCE MONTAŻU

Montaż oraz w razie potrzeby konserwacja i demontaż muszą być przeprowadzone przez wykwalifikowanego elektryka.

Montaż musi być zgodny z lokalnymi przepisami.

Sprawdź maksymalną długość obwodu grzewczego dla wyłącznika nadmiarowo-prądowego w następującej tabeli:

### Maksymalna długość obwodu przy 230 VAC i temperaturze rozruchu 5°C wyłącznik o charakterystyce C

W przypadku, gdy wymagane są dłuższe obwody przewodów grzejnych, można zastosować wiele urządzeń, w wielu punktach zasilania. Zalecamy użycie rozdzielnic nVent RAYCHEM SBS-FP-xx16A do obsługi 3, 6, 9 lub 12 obwodów grzejnych.

	10XL2-LH	15XL2-LH	26XL2-LH	31XL2-LH
Wyłącznik nadmiarowo-prądowy	(bordowy)	(zielony)	(niebieski)	(fioletowy)
<b>C 10A</b>	128 m	96 m	73 m	57 m
<b>C 13A</b>	166 m	125 m	94 m	74 m
<b>C 16A</b>	204 m	153 m	116 m	91 m
<b>C 20A</b>	238 m	188 m	142 m	114 m

Sterownik nVent RAYCHEM Raystat V5 jest wyposażony w zdejmowaną górną pokrywę. Zarówno górna jak i dolna część obudowy mają elektroniczne części i są połączone ze sobą za pomocą przewodu połączeniowego Ethernet. Jednostka jest dostarczana z pokrywą oddzieloną od obudowy.

**Ostrzeżenie:** W celu ochrony przed przepięciami (np. w przypadku burzy z piorunami) zalecamy zastosowanie zewnętrznego urządzenia zabezpieczającego przed przepięciami.

### Obsługa i konserwacja

Sterownik Raystat V5 można czyścić tylko miękką wilgotną szmatką, nie wolno używać żadnych rozpuszczalników. Nie polewać urządzenia wodą. Do czyszczenia nie używać węży lub myjek wysokociśnieniowych. Unikaj instalowania sterownika w pomieszczeniach o dużej wilgotności i kondensacji. Aby móc obsługiwać interfejs użytkownika, musi on być czysty i suchy. W przypadku instalacji na zewnątrz zaleca się stosowanie osłony przeciwsłonecznej i przeciwdeszczowej.

## Opis

nVent RAYCHEM Raystat V5 jest elektronicznym termostatem sterującym z wyświetlaczem, zaawansowanymi funkcjami alarmowymi oraz możliwością przełączania dużych prądów (25 A). Sterownik Raystat V5 jest zaprojektowany do sterowania systemami przewodów grzejnych nVent. Przewód grzejny może być sterowany (włączany/wyłączany) bezpośrednio przez termostat Raystat V5 lub przez stycznik.

Bezpośrednie przełączanie przewodów grzejnych jest możliwe dla systemów z obciążeniami do 25 A. W przypadku obciążeń powyżej 25 A konieczne jest pośrednie przełączanie przez stycznik o odpowiednich parametrach znamionowych, który jest kontrolowany przez sterownik Raystat V5.

Instalacja i wszystkie podłączenia muszą być zgodne z obowiązującymi przepisami. Urządzenie może być instalowane wyłącznie w strefach bezpiecznych. Firma nVent oferuje inne sterowniki do użytku w strefach zagrożonych wybuchem.

 Czujnik musi być zainstalowany. Uwaga: Umieszczenie czujnika na rurze lub w powietrzu musi być zgodne z trybem pracy: PiPE (pomiar temperatury rurociągu) lub Air. (PASC / sterowanie proporcjonalne względem temperatury otoczenia). Błędne umieszczenie czujnika może doprowadzić do zamarznięcia rury.

Zacisk alarmowy umożliwia zdalną sygnalizację potencjalnych błędów. Podczas uruchamiania urządzenia zaleca się symulację działania czujnika w trybie PIPE (pomiar temperatury rurociągu), ponieważ tryb AIR/PASC nie jest odpowiedni do tego testu ze względu na opóźnienie w algorytmie PASC. Urządzenie można zaprogramować w trybie wyłączonego zasilania za pomocą zewnętrznego źródła zasilania (power bank - zamawiany osobno) podłączonego za pomocą kabla USB (A-A) i złącza USB.

## Dane techniczne

Zastosowanie produktu	Wyłącznie przewody grzewcze nVent RAYCHEM do ochrony rurociągów przed zamarzaniem
<b>Parametry elektryczne</b>	
Napięcie zasilania	180–253 VAC, 50/60 Hz



Pobór mocy	5,3 W maks.																																								
Przełącznik mocy wyjściowej (przewód grzejny)	25 A / 230 VAC																																								
Zaciski zasilania	3 x 6 mm <sup>2</sup> maks.																																								
Zaciski przewodów grzejnych	3 x 6 mm <sup>2</sup> maks.																																								
Zaciski alarmowe	3 x 1,5 mm <sup>2</sup> maks.																																								
Zacisk czujnika – rurociąg	2 x 1,5 mm <sup>2</sup> maks.																																								
Przełącznik alarmowy	Przełącznik typu SPDT (jednobiegunowy dwupozytyjny), beznapięciowy; Maks. zdolność przełączeniowa (wyłącznie z obciążeniami rezystancyjnymi) 1 A / 30 VDC 0,5 A / 125 VAC, Maks.: 60 VDC / 125 VAC																																								
Ustawienia	Wszystkie ustawienia są zapisywane w pamięci nieulotnej																																								
Temperatura pracy	Temperatura otoczenia od -40°C do +40°C																																								
Nastawa temperatury	PiPE: Od 0°C do +90°C (PT 100 Sensor Module: -40°C ... +250°C: SM-PT100-1; PCN: 1244-022441) Air (PASC): Od 0°C do +30°C																																								
<b>Obudowa</b>																																									
Materiał	Poliwęglan																																								
Wymiary	210 mm x 90 mm x 85 mm																																								
Klasa stopnia ochrony (IP)	IP 65																																								
Waga	990 g																																								
Montaż	Montaż na szynie DIN 35 mm																																								
Wejścia	2 x M25 oraz 2 x M20																																								
Temperatura przechowywania	od -40°C do +50°C																																								
Klasa palności	Kategoria D (DIN EN 60730/VDE 0631-1)																																								
<b>Czujnik standardowy (w zestawie)</b>																																									
Typ czujnika temperatury	Standardowy NTC 2,0 kΩ przy 25°C, 2 przewody																																								
Wymiary końcówki czujnika	Ø 5 mm; długość 20 mm																																								
Długość przewodu czujnika	5 m; możliwość przedłużenia do 150 m, 2 x 1,5 mm <sup>2</sup>																																								
Zakres temperatur	od -40°C do +90°C																																								
Dane czujnika	<table border="1"> <thead> <tr> <th>Temperatura</th> <th>Opór w kΩ</th> </tr> </thead> <tbody> <tr><td>-40°C</td><td>32,34</td></tr> <tr><td>-35°C</td><td>24,96</td></tr> <tr><td>-30°C</td><td>19,48</td></tr> <tr><td>-25°C</td><td>15,29</td></tr> <tr><td>-20°C</td><td>12,11</td></tr> <tr><td>-15°C</td><td>9,655</td></tr> <tr><td>-10°C</td><td>7,763</td></tr> <tr><td>-5°C</td><td>6,277</td></tr> <tr><td>0°C</td><td>5,114</td></tr> <tr><td>+5°C</td><td>4,188</td></tr> <tr><td>+10°C</td><td>3,454</td></tr> <tr><td>+15°C</td><td>2,862</td></tr> <tr><td>+20°C</td><td>2,387</td></tr> <tr><td>+30°C</td><td>1,684</td></tr> <tr><td>+40°C</td><td>1,211</td></tr> <tr><td>+50°C</td><td>0,8854</td></tr> <tr><td>+60°C</td><td>0,6587</td></tr> <tr><td>+70°C</td><td>0,4975</td></tr> <tr><td>+80°C</td><td>0,3807</td></tr> </tbody> </table>	Temperatura	Opór w kΩ	-40°C	32,34	-35°C	24,96	-30°C	19,48	-25°C	15,29	-20°C	12,11	-15°C	9,655	-10°C	7,763	-5°C	6,277	0°C	5,114	+5°C	4,188	+10°C	3,454	+15°C	2,862	+20°C	2,387	+30°C	1,684	+40°C	1,211	+50°C	0,8854	+60°C	0,6587	+70°C	0,4975	+80°C	0,3807
Temperatura	Opór w kΩ																																								
-40°C	32,34																																								
-35°C	24,96																																								
-30°C	19,48																																								
-25°C	15,29																																								
-20°C	12,11																																								
-15°C	9,655																																								
-10°C	7,763																																								
-5°C	6,277																																								
0°C	5,114																																								
+5°C	4,188																																								
+10°C	3,454																																								
+15°C	2,862																																								
+20°C	2,387																																								
+30°C	1,684																																								
+40°C	1,211																																								
+50°C	0,8854																																								
+60°C	0,6587																																								
+70°C	0,4975																																								
+80°C	0,3807																																								

Dopuszczenia	Znak CE; EMC, zgodność z normą EN 50081-1/2 dla emisji i EN50082-1/2 dla odporności. Temperatura dla ciśnienia równoważącego +100°C test (DIN EN 60730/VDE 0631-1) Znamionowe napięcie udarowe: Kategoria przepięcia III (DIN EN 60730/ VDE 0631-1)
--------------	---

## Instalacja czujników dla wyższych zakresów temperatur:

Dla wyższych zakresów temperatur do 250°C można podłączyć czujnik typu PT100 za pomocą modułu SM-PT-100-1 (PCN: 1244-022441). Aby rozpoznać ten nowy moduł sprzętowy i aktywować nowy zakres temperatur, konieczne jest zresetowanie urządzenia.

Czujnik	Standardowy	Z modulem SM-PT100-1	
	(w zestawie)	HARD-78	MONI-PT100-260/2
Typ czujnika temperatury	NTC 2 KOhm / 25°C, 2-żyłowy	PT100	PT100
Wymiar końcówki czujnika	Ø 5 mm, długość 20 mm	Ø 6 mm, długość 50 mm	Ø 6 mm, długość 50 mm
Długość przewodu czujnika	5 m	3 m	2 m
Przedłużenie przewodu czujnika	Do 150 m, min. 2 x 1,5 mm <sup>2</sup>	Do 150 m, 3 x 1,5 mm <sup>2</sup>	Do 150 m, 3 x 1,5 mm <sup>2</sup>
Zakres temperatur	-40°C do +90°C	-40°C do +150°C	-50°C do +260°C

## DZIAŁANIE

Urządzenie Raystat V5 jest wyposażone w interfejs użytkownika z ekranem LED:

Urządzenie przełączy się na ekran główny po 2 minutach bez żadnej interakcji na ekranach wprowadzania parametrów.

## Szybka instalacja

Gdy jednostka zostanie włączona po raz pierwszy, należy przeprowadzić szybką konfigurację w celu przygotowania jej do pracy. Funkcja szybkiego startu pomaga w skonfigurowaniu wszystkich ważnych ustawień. Po zakończeniu urządzenie automatycznie przejdzie do ekranu głównego. Funkcja szybkiego startu jest wystarczającym rozwiązaniem w przypadku normalnej pracy. W przypadku specjalnych warunków instalacji należy użyć dodatkowych ustawień dostępnych w menu konfiguracji.

Funkcja szybkiego startu zostanie uruchomiona tylko, jeśli nie została przeprowadzona żadna wstępna konfiguracja.

**SZYBKI START** ➡ 64

**USTAWIENIE PARAMETRÓW** ➡ 71

## Przegląd parametrów:

PARAMETR	Tryb pracy: PiPE	Tryb pracy: Air = PASC	Opis	Nastawa fabryczna	Parametry
SP1	✓	✓	Ustawienie temperatury	+3°C	0°C ... +90°C
SP2	✓	✓	Wybór trybu pracy	---	PiPE / Air
SP3		✓	Najniższa temperatura otoczenia	-20°C	-30°C ... 0°C
SP4		✓	Średnia średnica rury	2 >= DN 25 / 1"	01 = Ø < DN 25 / 1" 02 = Ø ≥ DN 25 / 1" 03 = Ø ≥ DN 50 / 2"
SP5	✓	✓	Praca przewodu grzejnego w trybie awarii czujnika	ON.	ON/OFF
SP6	✓	✓	Zasilanie przewodu grzejnego przez zewnętrzny stycznik	No	Yes/No
SP7	✓		Histereza	1 K	0 K ... 5 K
SP8	✓		Alarm niskiej temperatury	0°C	OFF/-40°C
SP9	✓		Alarm wysokiej temperatury	+65°C	OFF/+65°C
SP10	✓	✓	Stan alarmów dźwiękowych	ON.	ON/OFF
SP11	✓	✓	Program TEST	OFF.	ON/OFF
SP12	✓	✓	BLOKADA – hasło	OFF.	OFF/code 036
SP13	✓	✓	RESET	000	Code 012

## Kody błędów:

Kod błędu	Opis błędu	Rozwiązanie
Er 2.1	Otwarty czujnik	1. Sprawdź połączenie przewodu czujnika 2. Sprawdź działanie urządzenia 3. Wymień urządzenie, jeśli przewód jest dobry i błąd nadal występuje
Er 2.2	Zwarcie czujnika	1. Sprawdź połączenie czujnika 2. Wymień czujnik 3. Wymień urządzenie, jeśli czujnik jest dobry i błąd nadal występuje
Er 3.1	Alarm wysokiej temperatury	1. Sprawdź system ogrzewania i umiejscowienie czujnika 2. Sprawdź w menu ustawień ustawienie alarmu wysokiej temperatury
Er 4.1	Alarm niskiej temperatury	1. Sprawdź system ogrzewania i umiejscowienie czujnika 2. Sprawdź w menu ustawień ustawienie alarmu niskiej temperatury
Er 6.0	Błąd wewnętrzny	Wymienić urządzenie

Kody błędów zostaną wyświetlone po upływie 10 minut.

## 1.3 POZNÁMKY K INSTALACI

Instalaci a v případě potřeby údržbu a demontáž musí provádět kvalifikovaný elektroinstalatér.

Instalace musí být v souladu s místními předpisy.

Vyhledejte maximální délku obvodu svého jističe v následující tabulce:

### Maximální délka obvodu při napětí 230 V AC a při teplotě spuštění 5°C

#### Jistič s charakteristikou C

Je možné použít více jednotek na více napájecích místech, pokud jsou potřeba delší topné kabely. K ovládní 3, 6, 9 a 12 topných okruhů doporučujeme používat panely nVent RAYCHEM SBS-FP-xx16A.

	10XL2-LH	15XL2-LH	26XL2-LH	31XL2-LH
Jistič	(červenofialová)	(zelená)	(modrá)	(fialová)
<b>C 10A</b>	128 m	96 m	73 m	57 m
<b>C 13A</b>	166 m	125 m	94 m	74 m
<b>C 16A</b>	204 m	153 m	116 m	91 m
<b>C 20A</b>	238 m	188 m	142 m	114 m

Jednotka nVent RAYCHEM Raystat V5 má odnímatelné horní víko. Spodní i horní část skříně obsahují elektronické součásti a jsou navzájem propojeny propojovacím kabelem sítě Ethernet. Jednotka je dodávána s demontovaným horním víkem a zadní stranou.

**Varování:** Jako ochranu proti přepětí (např. v případě bouřky) doporučujeme použít externí zařízení na ochranu proti přepětí.

#### Péče a údržba

Jednotku Raystat V5 čistíte pouze měkkým vlhkým hadříkem, nepoužívejte rozpouštědla. Na zařízení přímo nelijte vodu. Nepoužívejte vodní hadici ani vysokotlaký čistič.

Řídicí jednotku neinstalujte v místnostech s vysokou vlhkostí a kondenzací. Aby bylo možné ovládat uživatelské rozhraní, musí být čisté a suché. Pro venkovní instalaci bude doporučeno použít kryt proti slunci a dešti.

## Popis

Jednotka nVent RAYCHEM Raystat V5 je elektronicky řídicí termostat s displejem, pokročilými funkcemi alarmů a schopností spínat velké proudy (25 A). Jednotka Raystat V5 je určena k regulaci systémů topných kabelů nVent. Topný kabel lze ovládat (zapínat/vypínat) přímo jednotkou Raystat V5 nebo stykačem.

Přímé spínání topných kabelů je možné u topných zatížení do 25 A. U topných zatížení nad 25 A je nutné nepřímé spínání prostřednictvím vhodně dimenzovaného stykače regulovaného jednotkou Raystat V5.

Instalace a veškeré zapojení musí být v souladu s platnými předpisy. Zařízení smí být instalováno pouze do bezpečných prostředí. Společnost nVent nabízí také regulátory do nebezpečných prostředí.

 Čidlo musí být vždy nainstalováno. Pozor: Poloha čidla na potrubí nebo ve vzduchu musí odpovídat provoznímu režimu PiPE nebo Air. (PASC / teplota okolí řízení měření). Špatné přiřazení může vést k zamrznutí potrubí. Alarmový terminál umožňuje dálkovou signalizaci chyb. Při uvádění jednotky do provozu se doporučuje simulovat funkčnost snímače v režimu snímání PIPE, protože režim AIR/PASC není pro tento test vhodný z důvodu zpoždění algoritmu PASC. Jednotku lze předem naprogramovat ve vypnutém režimu vypnutí pomocí externí napájecí power banky (nutno objednat zvlášť) připojené kabelem A-A-USB a přípojkou USB.

## Technické údaje

<b>Použití produktu</b>	Pouze pro topné kabely nVent RAYCHEM na ochranu proti zamrznutí potrubí
<b>Elektrické vlastnosti</b>	
Napájecí napětí	180–253 VAC, 50/60 Hz
Příkon	5,3 W max.
Výkonové relé (topný kabel)	25 A / 230 V AC
Napájecí svorky	3 × 6 mm <sup>2</sup> max.

Svorky topného kabelu	3 × 6 mm <sup>2</sup> max.																																								
Svorky alarmu	3 × 1,5 mm <sup>2</sup> max.																																								
Svorka snímače – potrubí	2 × 1,5 mm <sup>2</sup> max.																																								
Relé alarmu	Jednopólové dvojité vypínací relé, beznapěťové, maximální kapacita spínání (pouze odporové zatížení) 1 A / 30 VDC 0,5 A / 125 VAC, max.: 60 VDC / 125 VAC																																								
Nastavení	Všechna nastavení jsou uložena v energeticky nezávislé paměti																																								
Provozní teplota	-40°C až 40°C, prostředí																																								
Volitelná teplota	PiPE: 0°C až +90°C (PT 100 Sensor Module: -40°C ... +250°C: SM-PT100-1; PCN: 1244-022441) Air (PASC): 0°C až +30°C																																								
<b>Pouzdro přístroje</b>																																									
Materiál	Polykarbonát																																								
Rozměry	210 mm × 90 mm × 85 mm																																								
Třída krytí	IP 65																																								
Hmotnost	990 g																																								
Montáž	Namontovatelné na DIN lištu 35 mm																																								
Vstupy	2 × M25 a 2 × M20																																								
Skladovací teplota	-40°C až +50°C																																								
Třída hořlavosti	Kategorie D (DIN EN 60730 / VDE 0631-1)																																								
<b>Standardní čidlo (je součástí balení)</b>																																									
Typ teplotního čidla	Standardní NTC 2,0 kΩ při 25°C, 2 vodiče																																								
Rozměry hrotu čidla	Ø 5 mm; délka 20 mm																																								
Délka kabelu čidla	5 m; možná délka až 150 m, 2 × 1,5 mm <sup>2</sup>																																								
Teplotní rozsah	-40°C až +90°C																																								
Data čidla	<table border="1"> <thead> <tr> <th>Teplota</th> <th>Odpor v kΩ</th> </tr> </thead> <tbody> <tr><td>-40°C</td><td>32,34</td></tr> <tr><td>-35°C</td><td>24,96</td></tr> <tr><td>-30°C</td><td>19,48</td></tr> <tr><td>-25°C</td><td>15,29</td></tr> <tr><td>-20°C</td><td>12,11</td></tr> <tr><td>-15°C</td><td>9,655</td></tr> <tr><td>-10°C</td><td>7,763</td></tr> <tr><td>-5°C</td><td>6,277</td></tr> <tr><td>0°C</td><td>5,114</td></tr> <tr><td>+5°C</td><td>4,188</td></tr> <tr><td>+10°C</td><td>3,454</td></tr> <tr><td>+15°C</td><td>2,862</td></tr> <tr><td>+20°C</td><td>2,387</td></tr> <tr><td>+30°C</td><td>1,684</td></tr> <tr><td>+40°C</td><td>1,211</td></tr> <tr><td>+50°C</td><td>0,8854</td></tr> <tr><td>+60°C</td><td>0,6587</td></tr> <tr><td>+70°C</td><td>0,4975</td></tr> <tr><td>+80°C</td><td>0,3807</td></tr> </tbody> </table>	Teplota	Odpor v kΩ	-40°C	32,34	-35°C	24,96	-30°C	19,48	-25°C	15,29	-20°C	12,11	-15°C	9,655	-10°C	7,763	-5°C	6,277	0°C	5,114	+5°C	4,188	+10°C	3,454	+15°C	2,862	+20°C	2,387	+30°C	1,684	+40°C	1,211	+50°C	0,8854	+60°C	0,6587	+70°C	0,4975	+80°C	0,3807
Teplota	Odpor v kΩ																																								
-40°C	32,34																																								
-35°C	24,96																																								
-30°C	19,48																																								
-25°C	15,29																																								
-20°C	12,11																																								
-15°C	9,655																																								
-10°C	7,763																																								
-5°C	6,277																																								
0°C	5,114																																								
+5°C	4,188																																								
+10°C	3,454																																								
+15°C	2,862																																								
+20°C	2,387																																								
+30°C	1,684																																								
+40°C	1,211																																								
+50°C	0,8854																																								
+60°C	0,6587																																								
+70°C	0,4975																																								
+80°C	0,3807																																								

Schválení	Označení CE; EMC Podle EN 50081-1/2 pro emise a EN50082 - 1/2 pro odolnost Teplota pro test tlaku koule +100 °C (DIN EN 60730/VDE 0631-1) Jmenovité impulzní napětí: Přepětí kategorie III (DIN EN 60730/ VDE 0631-1)
-----------	--

## Instalace snímače pro vyšší teplotní rozsahy:

Pro vyšší teplotní rozsahy do 250 °C lze připojit snímač typu PT100 pomocí modulu SM-PT-100-1 (PCN: 1244-022441). Pro rozpoznání tohoto nového hardwarového modulu a aktivaci nového teplotního rozsahu je třeba provést reset jednotky.

Čidlo	Standardní	S modulem SM-PT100-1	
	(Je součástí balení)	HARD-78	MONI-PT100-260/2
Typ teplotního čidla	NTC 2 KOhm / 25°C, dvoužilové	PT100	PT100
Rozměry hrotu čidla	Ø 5 mm, délka 20 mm	Ø 6 mm, délka 50 mm	Ø 6 mm, délka 50 mm
Délka kabelu čidla	5 m	3 m	2 m
Prodloužení kabelu	Až 150 m, min. 2 x 1,5 mm <sup>2</sup>	Až 150 m, 3 x 1,5 mm <sup>2</sup>	Až 150 m, 3 x 1,5 mm <sup>2</sup>
Teplotní rozsah	-40°C až +90°C	-40°C až +150°C	-50°C až +260°C

## OVLÁDÁNÍ

Jednotka Raystat V5 má LED displej s uživatelským rozhraním:

Jednotka se po 2 minutách nečinnosti na obrazovce při zadávání parametrů přepne na hlavní obrazovku.

## Rychlá instalace

Při prvním zapnutí jednotky je třeba provést rychlé nastavení předtím, než je jednotka připravena k provozu. Rychlé nastavení slouží k nastavení všech důležitých parametrů. Po dokončení se jednotka automaticky přepne do režimu hlavní obrazovky. Rychlé nastavení stačí pro normální provoz. Více nastavení je k dispozici v nabídce „Setup“ (Nastavení) pro zvláštní instalace.

Rychlé nastavení se spustí pouze v případě, že nebylo provedeno přednastavení.

**RYCHLÝ START ➡ 64**

**NASTAVENÍ PARAMETRŮ ➡ 71**

## Přehled parametrů:

PARAMETR	Provozní režim: PiPE	Provozní režim: Air = PASC	Popis	Tovární nastavení	Parametry
SP1	✓	✓	NASTAVIT teplotu	+3°C	0°C ... +90°C
SP2	✓	✓	Výběr provozního režimu	---	PiPE / Air
SP3		✓	Nejnižší teplota prostředí	-20°C	-30°C ... 0°C
SP4		✓	Průměrný průměr potrubí	2 >= DN 25 / 1"	01 = Ø < DN 25 / 1" 02 = Ø ≥ DN 25 / 1" 03 = Ø ≥ DN 50 / 2"
SP5	✓	✓	Výstupní relé termostatu bude při selhání čidla	ON	ON/OFF
SP6	✓	✓	Spínání topného kabelu prostřednictvím externího stykače	No	Yes/No
SP7	✓		Hystereze	1 K	0 K ... 5 K
SP8	✓		Alarm nízké teploty	0°C	OFF/-40°C
SP9	✓		Alarm vysoké teploty	+65°C	OFF/+65°C
SP10	✓	✓	Stav zvukového alarmu	ON	ON/OFF
SP11	✓	✓	Program TEST	OFF	ON/OFF
SP12	✓	✓	ZÁMEK TLAČÍTEK	OFF	OFF/code 036
SP13	✓	✓	RESET	000	Code 012

## Chybové kódy:

Chybový kód	Popis chyby	Řešení
Er 2.1	Rozpojené čidlo	1. Ověřte připojení kabelů čidla 2. Ověřte fungování jednotky 3. Vyměňte jednotku, pokud je kabel v pořádku a chyba zůstává
Er 2.2	Zkrat čidla	1. Ověřte připojení čidla 2. Vyměňte čidlo 3. Vyměňte jednotku, pokud je čidlo v pořádku a chyba zůstává
Er 3.1	Alarm vysoké teploty	1. Zkontrolujte topný systém a umístění čidla 2. Zkontrolujte nastavení alarmu vysoké teploty
Er 4.1	Alarm nízké teploty	1. Zkontrolujte topný systém a umístění čidla 2. Zkontrolujte nastavení alarmu nízké teploty
Er 6.0	Vnitřní chyba	Vyměňte jednotku

Chybové kódy se zobrazí s časovou prodlevou 10 minut.

## 1.3 安装注意事项

装置的安装及必要维护拆卸须由资质合格的电工执行。

安装须符合本地电气法规要求。

根据下表检查断路器的最大电路长度：

### 230 VAC 和 5°C 启动温度时的最大回路长度

#### C 型断路器

如需更长的伴热电缆，可在多个电插座上使用多个装置。我们建议使用 nVent RAYCHEM SBS-FP-xx16A 配电柜来控制 3, 6, 9 或 12 回路。

	10XL2-LH (紫红)	15XL2-LH (绿色)	26XL2-LH (蓝色)	31XL2-LH (紫色)
断路器				
C 10A	128 米	96 米	73 米	57 米
C 13A	166 米	125 米	94 米	74 米
C 16A	204 米	153 米	116 米	91 米
C 20A	238 米	188 米	142 米	114 米

nVent RAYCHEM Raystat V5 带有一个可拆卸式顶盖。盒子的顶部和底部都有电子部件，通过以太网连接电缆相互连接。该装置提交的时候是拆除了顶盖和后侧零件的。

**警告：**为防止过压（例如，发生雷暴时），我们建议使用外部过压保护装置。

#### 护理和维护

只能用柔软湿抹布清洁 Raystat V5，切勿使用任何清洁剂。切勿将水直接倒在设备上。请勿使用水管或高压清洁剂。避免在高湿度和冷凝的房间安装控制器。操作用户界面时，必须保持干净干燥。对于室外安装建议使用防晒和防雨罩

## 描述

nVent RAYCHEM Raystat V5 是一款电子控制温控器，配备显示器、高级报警装置以及大电流 (25 A) 切换功能。Raystat V5 用于控制 nVent 伴热电缆系统。伴热电缆可直接通过 Raystat V5 控制，或通过接触器控制（开/关）。

25 A 以内的热负荷支持直接切换伴热电缆。25 A 以上的热负荷需要通过适当的额定接触器间接切换，接触器由 Raystat V5 控制。

安装以及所有接线都必须遵照适用的法规。设备须安装于非危险区域。nVent 可提供适合危险区域的其他控制装置。



必须安装传感器。注意：传感器在管道上或空气中的位置需与操作模式管道上或空气中（PASC 环境温度测量控制）相匹配。错误分配可能导致管道冻结。报警终端可远程报告错误。可使用经 A-A-USB 电缆和 USB 连接的外部移动电源（单独订购），在关机模式下预先设定装置。

## 技术数据

产品规格	仅限 nVent RAYCHEM 管道防冻伴热电缆
<b>电气属性</b>	
电源电压	180-253 VAC; 50/60Hz
功率消耗	最大 5,3 W
功率输出继电器（伴热电缆）	25 A / 230 VAC
电源端子	最大 3 x 6 mm <sup>2</sup>
伴热电缆端子	最大 3 x 6 mm <sup>2</sup>
报警端子	最大 3 x 1,5 mm <sup>2</sup>
传感器端子 - 管道	最大 2 x 1,5 mm <sup>2</sup>
报警继电器	单极双掷继电器，无电压；最大交换容量（仅电阻负载） 1 A/30 VDC 0.5 A/125 VAC，最大： 60 VDC/125 VAC
设置	所有设置都存储在非易失性介质中。
工作温度	-40°C 至 +40°C 环境



可选择温度	PiPE: 0°C ... +90°C (PT 100 Sensor Module: -40°C ... +250°C: SM-PT100-1; PCN: 1244-022441) Air (PASC): 0°C ... +30°C																																									
<b>外壳</b>																																										
材料	聚碳酸酯																																									
尺寸	210 mm x 90 mm x 85 mm																																									
防护等级	IP 65																																									
重量	990 g																																									
安装	可安装 DIN 轨道 35 mm																																									
入口	2 x M25 和 2 x M20																																									
存储温度	-40°C ~ +50°C																																									
可燃性等级	D 类别 (DIN EN 60730/VDE 0631-1)																																									
<b>标准传感器在包装内</b>																																										
温度传感器类型	标准 NTC 2,0 kOhm , 25°C , 2 线																																									
传感器尖端尺寸	Ø 5 mm ; 长度 20 mm																																									
传感器电缆长度	5 m ; 最多可延长到 150 m , 2 x1,5 mm <sup>2</sup>																																									
温度范围	-40°C 至 +90°C																																									
传感器数据	<table border="1"> <thead> <tr> <th>温度</th> <th>电阻 (kOhm)</th> </tr> </thead> <tbody> <tr><td>-40°C</td><td>32,34</td></tr> <tr><td>-35°C</td><td>24,96</td></tr> <tr><td>-30°C</td><td>19,48</td></tr> <tr><td>-25°C</td><td>15,29</td></tr> <tr><td>-20°C</td><td>12,11</td></tr> <tr><td>-15°C</td><td>9,655</td></tr> <tr><td>-10°C</td><td>7,763</td></tr> <tr><td>-5°C</td><td>6,277</td></tr> <tr><td>0°C</td><td>5,114</td></tr> <tr><td>+5°C</td><td>4,188</td></tr> <tr><td>+10°C</td><td>3,454</td></tr> <tr><td>+15°C</td><td>2,862</td></tr> <tr><td>+20°C</td><td>2,387</td></tr> <tr><td>+30°C</td><td>1,684</td></tr> <tr><td>+40°C</td><td>1,211</td></tr> <tr><td>+50°C</td><td>0,8854</td></tr> <tr><td>+60°C</td><td>0,6587</td></tr> <tr><td>+70°C</td><td>0,4975</td></tr> <tr><td>+80°C</td><td>0,3807</td></tr> </tbody> </table>		温度	电阻 (kOhm)	-40°C	32,34	-35°C	24,96	-30°C	19,48	-25°C	15,29	-20°C	12,11	-15°C	9,655	-10°C	7,763	-5°C	6,277	0°C	5,114	+5°C	4,188	+10°C	3,454	+15°C	2,862	+20°C	2,387	+30°C	1,684	+40°C	1,211	+50°C	0,8854	+60°C	0,6587	+70°C	0,4975	+80°C	0,3807
温度	电阻 (kOhm)																																									
-40°C	32,34																																									
-35°C	24,96																																									
-30°C	19,48																																									
-25°C	15,29																																									
-20°C	12,11																																									
-15°C	9,655																																									
-10°C	7,763																																									
-5°C	6,277																																									
0°C	5,114																																									
+5°C	4,188																																									
+10°C	3,454																																									
+15°C	2,862																																									
+20°C	2,387																																									
+30°C	1,684																																									
+40°C	1,211																																									
+50°C	0,8854																																									
+60°C	0,6587																																									
+70°C	0,4975																																									
+80°C	0,3807																																									
认证	CE认证, EMC 依据 EN60730 EMC 依据 EN 50081-1/2 排放和 EN50082 - 1/2 抗干扰性标准 平衡压力温度 +100°C 测试 (DIN EN 60730/VDE 0631-1) 额定脉冲电压: 过压类别 III (DIN EN 60730/VDE 0631-1)																																									

## 当感应电缆安装在高温区域：

对于高达250°C的温度范围，可使用传感器插件模块SM-PT-100-1 ( PCN:1244-022441 ) 连接PT100型传感器。需要重置该单元才能识别新的硬件模块并激活新的温度范围。

传感器	标准	带 SM-PT100-1	
	(在包装内)	HARD-78	MONI-PT100-260/2
温度传感器类型	NTC 2 KOhm / 25°C, 2-wire	PT100	PT100
传感器端头直径	Ø 5 mm, 长度 20 mm	Ø 6 mm, 长度 50 mm	Ø 6 mm, 长度 50 mm
传感线长度	5 m	3 m	2 m
传感线可延长至	延长至 150 m, min. 2 x 1,5 mm <sup>2</sup>	延长至 150 m, 3 x 1,5 mm <sup>2</sup>	延长至 150 m, 3 x 1,5 mm <sup>2</sup>
温度范围	-40°C 至 +90°C	-40°C 至 +150°C	-50°C 至 +260°C

## 操作

Raystat V5 配备 LED 用户屏幕界面：

若 2 分钟内参数输入屏幕上无任何操作，装置将恢复为主屏幕模式。

## 快速安装

首次开启装置时，须执行快速设置，然后再开启装置。快速启动帮助用户设置所有重要设置，装置将在完成设置之后进入主屏幕模式。快速启动足以执行一般操作。对于特殊安装条件，在设置菜单中有更多设置可用。

快速启动仅在无预先设置的情况下才会启动。

按住对勾按钮 6 秒，可更改参数。

控制器可由键盘锁保护。如果启用键盘锁功能，则需输入代码（见参数列表中的 SP 12）才可解锁装置。同时按住向上、向下箭头和 OK 按钮 6 秒钟，可将 Raystat V5 恢复为出厂设置。

**快速启动** ➡ 64

**参数设定** ➡ 71

## 参数概览：

参数	操作模式： PiPE	操作模式： Air = PASC	描述	出厂设置	参数
SP1	✓	✓	设定温度	+3°C	0°C ... +90°C
SP2	✓	✓	操作模式选择	-----	PiPE / Air
SP3		✓	最低环境温度	-20°C	-30°C ... 0°C
SP4		✓	平均管径级别	$\begin{matrix} 2 \\ \geq \text{DN } 25 \\ / 1" \end{matrix}$	$\begin{matrix} 01 = \varnothing < \text{DN} \\ 25 / 1" \\ 02 = \varnothing \geq \text{DN} \\ 25 / 1" \\ 03 = \varnothing \geq \text{DN} \\ 50 / 2" \end{matrix}$
SP5	✓	✓	传感器故障模式下的加热器运行	ON	ON/OFF
SP6	✓	✓	加热器借助外部接触器运行	No	Yes/No
SP7	✓		磁滞	1 K	0 K ... 5 K
SP8	✓		低温报警	0°C	OFF/-40°C
SP9	✓		高温报警	+65°C	OFF/+65°C
SP10	✓	✓	报警声音状态	ON	ON/OFF
SP11	✓	✓	测试程序	OFF	ON/OFF
SP12	✓	✓	键盘锁 - 密码	OFF	OFF/code 036
SP13	✓	✓	重启	000	Code 012

## 错误代码：

错误代码	错误描述	纠正措施
Er 2.1	传感器打开	<ol style="list-style-type: none"><li>1. 检查传感器电缆连接</li><li>2. 确认装置运行情况</li><li>3. 若电缆良好但错误仍然存在，则更换装置</li></ol>
Er 2.2	传感器短路	<ol style="list-style-type: none"><li>1. 检查传感器连接</li><li>2. 更换传感器</li><li>3. 若传感器良好但错误仍然存在，则更换装置</li></ol>
Er 3.1	高温报警	<ol style="list-style-type: none"><li>1. 确认伴热系统和传感器位置</li><li>2. 确认高温报警菜单设置</li></ol>
Er 4.1	低温报警	<ol style="list-style-type: none"><li>1. 确认伴热系统和传感器位置</li><li>2. 确认低温报警菜单设置</li></ol>
Er 6.0	内部错误	更换装置

故障代码显示会有10秒延迟。

## 1.3 Указания по монтажу

Установку и, если требуется, техобслуживание и демонтаж, должен выполнять квалифицированный электромонтажник.

Установка должна выполняться в соответствии с местными нормами и правилами.

Проверьте соответствие длины кабеля, подключенного к автоматическому выключателю, максимально допустимым значениям, приведенным в таблице:

**Максимальная длина контура при 230 В перемен. тока и для температуры запуска 5°C**

**Автоматический выключатель с характеристикой С.**

Можно использовать несколько устройств на несколько точек подвода питания, если требуется обогреть участки большей длины. Рекомендуем использовать панели nVent RAYCHEM SBS-FP-xx16A для управления 3, 6, 9 или 12 контурами обогрева.

	10XL2-LH	15XL2-LH	26XL2-LH	31XL2-LH
Автоматический выключатель	(Сливовый)	(Зеленый)	(Синий)	(Пурпурный)
<b>С 10А</b>	128 м	96 м	73 м	57 м
<b>С 13А</b>	166 м	125 м	94 м	74 м
<b>С 16А</b>	204 м	153 м	116 м	91 м
<b>С 20А</b>	238 м	188 м	142 м	114 м

nVent RAYCHEM Raystat V5 имеет съемную переднюю крышку. Как в верхней, так и в нижней части бокса есть электронные компоненты, они соединяются друг с другом с помощью соединительного Ethernet-кабеля. Устройство поставляется со снятыми передней и задней крышками.

**Предупреждение.** Для защиты от перенапряжения (например, на случай грозы), рекомендуем использовать внешнее устройство защиты от перенапряжения.

### Уход и обслуживание

Чистите Raystat V5 только мягкой влажной тканью, не используйте никакие растворители. Не лейте воду непосредственно на устройство. Не используйте шланг для воды или очиститель высокого давления. Избегайте установки контроллера в помещениях с высокой влажностью и конденсатом. Для работы с интерфейсом пользователя экран должен быть чистым и сухим. При установке на улице рекомендуется использовать навес для защиты от солнца и дождя.

## Описание

nVent RAYCHEM Raystat V5 – это термостат с электронным управлением, с дисплеем, обеспечивающий расширенные функции сигнализации и способный переключать большие токи (25 А). Raystat V5 предназначен для управления системами кабельного обогрева nVent. Управление греющим кабелем (переключение ВКЛ./ВЫКЛ.) может осуществляться или напрямую через Raystat V5, или через контактор.

Прямое подключение греющего кабеля возможно для нагрузок до 25 А. Для нагрузок свыше 25 А требуется подключение через контактор с соответствующими параметрами, управляемый термостатом Raystat V5.

При выполнении монтажа и электромонтажных работ необходимо строго соблюдать требования всех применимых норм. Устройство должно быть установлено только в неопасных зонах. Для применения во взрывоопасных зонах nVent выпускает специальные устройства управления.



Датчик должен быть обязательно закреплен. Внимание: Положение датчика на трубе или на воздухе должно соответствовать рабочему режиму PIPE или Air. (PASC / пропорциональное регулирование по температуре окружающей среды). Неправильная настройка может привести к замерзанию трубы.

Клемма аварийной сигнализации позволяет дистанционно передавать сигналы об ошибках. При вводе устройства в эксплуатацию рекомендуется имитировать работу датчика в режиме измерения температуры на поверхности трубы PIPE, так как режим AIR/PASC не подходит для этого теста из-за задержки в алгоритме PASC. Устройство может быть предварительно запрограммировано в режим отключения питания с помощью внешнего блока питания (заказывается отдельно), подключаемого через кабель A-A-USB и USB-соединение.

## Технические характеристики

Применение изделия	Только греющие кабели nVent RAYCHEM для защиты трубопроводов от замерзания
<b>Электрические характеристики</b>	
Напряжение питания	180-253 В перемен. тока; 50/60 Гц
Потребляемая мощность	5,3 Вт макс.

Реле выходной мощности (греющий кабель)	25 А / 230 В перемен. тока																																								
Клеммы подвода питания	3 x 6 мм <sup>2</sup> макс.																																								
Клеммы греющего кабеля	3 x 6 мм <sup>2</sup> макс.																																								
Клеммы аварийной сигнализации	3 x 1,5 мм <sup>2</sup> макс.																																								
Клемма датчика - трубопровод	2 x 1,5 мм <sup>2</sup> макс.																																								
Реле аварийной сигнализации	Однополюсное двухпозиционное реле, «сухие контакты»; макс. переключающая способность (только резистивная нагрузка) 1 А/30 В пост. ток 0,5 А/125 В перемен. ток, макс.: 60 В пост. ток/ 125 В перемен. ток																																								
Настройки	Все настройки сохраняются в энергонезависимой памяти																																								
Рабочая температура	от -40°C до +40°C окружающей среды																																								
Настраиваемая температура	PiPE: от 0°C до +90°C (PT 100 Sensor Module: -40°C ... +250°C: SM-PT100-1; PCN: 1244-022441) Air (PASC): от 0°C до +30°C																																								
<b>Корпус</b>																																									
Материал	Поликарбонат																																								
Размеры	210 мм x 90 мм x 85 мм																																								
Класс защиты	IP 65																																								
Масса	990 г																																								
Монтаж	Монтируется на DIN-рейку 35 мм																																								
Вводы	2 x M25 и 2 x M20																																								
Температура хранения	от -40°C до +50°C																																								
Класс пожароопасности	Категория D (DIN EN 60730/VDE 0631-1)																																								
<b>Стандартный датчик (входит в комплект поставки)</b>																																									
Тип датчика температуры	Стандартный NTC 2,0 кОм при 25°C, 2 провода																																								
Размеры наконечника датчика	Ø 5 мм; длина 20 мм																																								
Длина кабеля датчика	5 м; может быть увеличена до 150 м, 2 x 1,5 мм <sup>2</sup>																																								
Диапазон температуры	от -40°C до +90°C																																								
Данные датчика	<table border="1"> <thead> <tr> <th>Температура</th> <th>Сопротивление в кОм</th> </tr> </thead> <tbody> <tr><td>-40°C</td><td>32,34</td></tr> <tr><td>-35°C</td><td>24,96</td></tr> <tr><td>-30°C</td><td>19,48</td></tr> <tr><td>-25°C</td><td>15,29</td></tr> <tr><td>-20°C</td><td>12,11</td></tr> <tr><td>-15°C</td><td>9,655</td></tr> <tr><td>-10°C</td><td>7,763</td></tr> <tr><td>-5°C</td><td>6,277</td></tr> <tr><td>0°C</td><td>5,114</td></tr> <tr><td>+5°C</td><td>4,188</td></tr> <tr><td>+10°C</td><td>3,454</td></tr> <tr><td>+15°C</td><td>2,862</td></tr> <tr><td>+20°C</td><td>2,387</td></tr> <tr><td>+30°C</td><td>1,684</td></tr> <tr><td>+40°C</td><td>1,211</td></tr> <tr><td>+50°C</td><td>0,8854</td></tr> <tr><td>+60°C</td><td>0,6587</td></tr> <tr><td>+70°C</td><td>0,4975</td></tr> <tr><td>+80°C</td><td>0,3807</td></tr> </tbody> </table>	Температура	Сопротивление в кОм	-40°C	32,34	-35°C	24,96	-30°C	19,48	-25°C	15,29	-20°C	12,11	-15°C	9,655	-10°C	7,763	-5°C	6,277	0°C	5,114	+5°C	4,188	+10°C	3,454	+15°C	2,862	+20°C	2,387	+30°C	1,684	+40°C	1,211	+50°C	0,8854	+60°C	0,6587	+70°C	0,4975	+80°C	0,3807
	Температура	Сопротивление в кОм																																							
	-40°C	32,34																																							
	-35°C	24,96																																							
	-30°C	19,48																																							
	-25°C	15,29																																							
	-20°C	12,11																																							
	-15°C	9,655																																							
	-10°C	7,763																																							
	-5°C	6,277																																							
	0°C	5,114																																							
	+5°C	4,188																																							
	+10°C	3,454																																							
	+15°C	2,862																																							
	+20°C	2,387																																							
	+30°C	1,684																																							
	+40°C	1,211																																							
	+50°C	0,8854																																							
+60°C	0,6587																																								
+70°C	0,4975																																								
+80°C	0,3807																																								

Сертификация	Маркировка CE; ЭМС электромагнитная совместимость согласно EN 50081-1/2 для эмиссии и EN50082 - 1/2 для помехоустойчивости Температура для испытания давлением шарика +100°C (DIN EN 60730/VDE 0631-1) Номинальное импульсное напряжение: категория перенапряжения III согласно DIN EN 60730/ VDE 0631-1
--------------	--

## Установка датчика для более высоких температурных диапазонов:

Для более высоких температурных диапазонов до 250°C можно подключить датчик типа PT100 с помощью модуля подключения датчика SM-PT-100-1 (PCN: 1244-022441). Для распознавания нового устройства и активации нового температурного диапазона требуется перезагрузка устройства.

Датчик	Стандартный	С модулем SM-PT100-1	
	(в комплекте)	HARD-78	MONI-PT100-260/2
Тип датчика	NTC 2 Ком / 25°C, 2-х проводной	PT100	PT100
Датчик тип и размер	Ø 5 мм, длина 20 мм	Ø 6 мм, длина 50 мм	Ø 6 мм, длина 50 мм
Длина датчика	5 м	3 м	2 м
Возможность удлинения	До 150 м, мин. 2 x 1,5 мм <sup>2</sup>	До 150 м, 3 x 1,5 мм <sup>2</sup>	До 150 м, 3 x 1,5 мм <sup>2</sup>
Температура эксплуатации	-40°C до +90°C	-40°C до +150°C	-50°C до +260°C

## ЭКСПЛУАТАЦИЯ

Raystat V5 имеет терминал настройки со светодиодным экраном:

устройство переключается на главный экран через 2 минуты бездействия на экранах ввода параметров.

### Быстрая установка

При первоначальном включении устройства необходимо выполнить процедуру быстрой настройки, прежде чем блок перейдет в режим готовности к работе. Быстрый запуск помогает произвести все важные настройки, после выполнения устройство автоматически перейдет в режим главного экрана. Быстрого запуска достаточно для обычной работы. Более расширенные настройки для особых условий установки находятся в меню «Настройки».

Быстрый старт запустится только, если не были сделаны никакие предварительные настройки.

**Быстрый запуск** ➡ 64

**Настройка параметров** ➡ 71

## Обзор параметров:

ПАРА-МЕТР	Рабочий режим: PiPE	Рабочий режим: Air = PASC	Описание	Заводские настройки	Параметры
SP1	✓	✓	Заданная температура	+3°C	0°C ... +90°C
SP2	✓	✓	Выбор рабочего режима	----	PiPE / Air
SP3		✓	Самая низкая температура окружающей среды	-20°C	-30°C ... 0°C
SP4		✓	Средний диаметр трубы	2 >= DN 25 / 1"	01 = Ø < DN 25 / 1" 02 = Ø ≥ DN 25 / 1" 03 = Ø ≥ DN 50 / 2"
SP5	✓	✓	Работа обогрева при отказе датчика	ON	ON/OFF
SP6	✓	✓	Работа обогрева через внешний контактор	No	Yes/No
SP7	✓		Гистерезис	1 K	0 K ... 5 K
SP8	✓		Сигнал тревоги низкой температуры	0°C	OFF/-40°C
SP9	✓		Сигнал тревоги высокой температуры	+65°C	OFF/+65°C
SP10	✓	✓	Состояние звукового сигнала тревоги	ON	ON/OFF
SP11	✓	✓	Программа тестирования	OFF	ON/OFF
SP12	✓	✓	Блокировка клавиатуры – проходной код	OFF	OFF/code 036
SP13	✓	✓	Сброс	000	Code 012

## Коды ошибок:

Код ошибки	Описание ошибки	Устранение
Er 2.1	Датчик разомкнут	1. Проверьте кабельное соединение датчика 2. Проверьте работу устройства 3. Замените устройство, если кабель в порядке, а ошибка не исчезает
Er 2.2	Короткое замыкание датчика	1. Проверьте соединение датчика 2. Замените датчик 3. Замените устройство, если датчик в порядке, а ошибка не исчезает
Er 3.1	Сигнал тревоги высокой температуры	1. Проверьте систему обогрева и положение датчика 2. Проверьте в меню настройки сигнала тревоги высокой температуры
Er 4.1	Сигнал тревоги низкой температуры	1. Проверьте систему обогрева и положение датчика 2. Проверьте в меню настройки сигнала тревоги низкой температуры
Er 6.0	Внутренняя ошибка	Замените устройство

Коды ошибок будут отображаться после временной задержки в 10 мин.

## 1.3 PASTABOS DĖL MONTAVIMO

Montavimo, priežiūros bei išmontavimo darbus turi atlikti kvalifikuotas elektrinės įrangos montuotojas.

Montavimo darbai turi atitikti vietos teisės aktus.

Toliau pateiktoje lentelėje patikrinkite maksimalų grandinės pagal jūsų automatinio jungiklio nominalą.

**Maksimalus grandinės ilgis esant 230 V AC ir 5°C paleidimo temperatūrai**

### C charakteristikos automatinis jungiklis

Jei reikia ilgesnių šildymo kabelių, galima naudoti kelis įrenginius su keliais maitinimo taškais. Norint valdyti 3, 6, 9 arba 12 šildymo grandinių, rekomenduojame naudoti „nVent“ RAYCHEM SBS-FP-xx16A valdymo skydus

	10XL2-LH	15XL2-LH	26XL2-LH	31XL2-LH
Automatinis jungiklis	(Tamsiai violetinis)	(Žalias)	(Mėlynas)	(Violetinis)
<b>C 10A</b>	128 m	96 m	73 m	57 m
<b>C 13A</b>	166 m	125 m	94 m	74 m
<b>C 16A</b>	204 m	153 m	116 m	91 m
<b>C 20A</b>	238 m	188 m	142 m	114 m

„nVent RAYCHEM Raystat V5“ yra su nuimamu viršutiniu dangčiu. Elektroninių dalių yra ir dėžės viršuje, ir apačioje, jos sujungtos tarpusavyje eterneito jungties kabeliu. Įrenginys pristatomas nuėmus viršutinį dangtį ir galinę dalį.

**Įspėjimas.** Apsaugai nuo įtampos (pvz., perkūnijoms atveju) rekomenduojame naudoti išorinį apsaugos nuo viršįtampio įrenginį.

### Įprastinė ir techninė priežiūra

Valykite „Raystat V5“ tik minkšta drėgna šluoste, nenaudokite jokių tirpiklių. Nepilkite vandens tiesiai ant įrenginio. Nenaudokite vandens žarnos arba valymo aukštu slėgiu įrangos. Venkite įrengti valdiklį patalpoje, kurioje yra didelė drėgmė ir kondensacija. Naudojantis meniu, šviesadiodis ekranas ir mygtukai turi būti švarūs ir sausi. Montuojant lauko sąlygomis, rekomenduojama naudoti apsaugą nuo saulės ir lietaus.

## Aprašymas

„nVent RAYCHEM Raystat V5“ – tai elektroninis reguliavimo termostatas su ekranu, pažangiomis signalizacijos funkcijomis ir galimybe perjungti stiprias sroves (25 A). „Raystat V5“ skirtas „nVent“ šildymo kabelių sistemoms valdyti. Valdyti (įjungti / išjungti) šildymo kabelį galima tiesiogiai naudojantis „Raystat V5“ arba per kontaktorių.

Tiesiogiai perjungti šildymo kabelius galima naudojant iki 25 A šildymo apkrovą. Jei šildymo apkrova didesnė nei 25 A, būtinas netiesioginis perjungimas per tinkamos galios kontaktorių, kurį valdo „Raystat V5“.

Visi montavimo ir laidų prijungimo darbai turi atitikti taikomas taisykles. Montuoti įrenginį leidžiama tik nepavojingose zonose. Jei reikia montuoti pavojingose zonose, galima rinktis iš kitų „nVent“ siūlomų valdiklių.

 Turi būti sumontuotas jutiklis. Dėmesio! Jutiklio padėtis ant vamzdžio arba ore turi atitikti darbo režimą „PIPE“ arba Air. (PASC / aplinkos temperatūros matavimo valdymas). Priskyrus netinkamai, vamzdis gali užšalti. Pavojaus signalų gnybtas suteikia galimybę pranešti apie klaidas nuotoliniu būdu. Atliekant bandymus įrenginį rekomenduojama naudoti „PIPE“ režime, nes AIR/PASC režimas nėra tinkamas bandymams dėl PASC algoritmo uždelsimo. Galima iš anksto užprogramuoti įrenginį galios išjungimo režimu naudojant išorinį maitinimo bloką (užsakomą atskirai), prijungtą A-A-USB kabeliu ir USB jungtimi.

## Techniniai duomenys

<b>Gaminio paskirtis</b>	Tik „nVent RAYCHEM“ vamzdžių apsaugos nuo užšalimo kabeliai
<b>Elektros duomenys</b>	
Maitinimo įtampa	180–253 V AC; 50/60 Hz
Energijos sąnaudos	5,3 W maks.
Išėjimo relė (šildymo kabelis)	25 A / 230 V AC
Maitinimo kabelio gnybtai	3 x 6 mm <sup>2</sup> maks.
Šildymo kabelio gnybtai	3 x 6 mm <sup>2</sup> maks.



Signalizacijos gnybtai	3 x 1,5 mm <sup>2</sup> maks.																																								
Jutiklio gnybtas – vamzdis	2 x 1,5 mm <sup>2</sup> maks.																																								
Signalizacijos relė	Vieno poliaus dvikryptė relė, be įtampos; maks. perjungimo geba (tik varžinė apkrova) 1 A / 30 V DC 0,5 A / 125 V AC, maks.: 60 V DC / 125 V AC																																								
Nustatymai	Visi nustatymai saugomi netriniojoje atmintyje																																								
Darbinė temperatūra	Nuo –40°C iki +40°C, aplinkos																																								
Pasirenkama temperatūra	PiPE: Nuo 0°C iki +90°C (PT 100 Sensor Module: –40°C ... +250°C: SM-PT100-1; PCN: 1244-022441) Air (PASC): Nuo 0°C iki +30°C																																								
<b>Korpusas</b>																																									
Medžiaga	Polikarbonatas																																								
Matmenys	210 mm x 90 mm x 85 mm																																								
Atsparumo klasė	IP 65																																								
Svoris	990 g																																								
Montavimas	Montuojama ant DIN bėgelio, 35 mm																																								
Įvadai	2 x M25 ir 2 x M20																																								
Saugojimo temperatūra	Nuo –40°C iki +50°C																																								
Užsiliepsnojamumo klasė	D kategorija (DIN EN 60730 / VDE 0631-1)																																								
<b>Standartinis jutiklis (yra dėžutėje)</b>																																									
Temperatūros jutiklio tipas	Standartinis NTC 2,0 kOhm esant 25°C, 2 laidai																																								
Jutiklio antgalio matmenys	Ø 5 mm; ilgis 20 mm																																								
Jutiklio kabelio ilgis	5 m; galima padidinti iki 150 m, 2x1,5 mm <sup>2</sup>																																								
Temperatūros diapazonas	Nuo –40°C iki +90°C																																								
Jutiklio duomenys	<table border="1"> <thead> <tr> <th>Temperatūra</th> <th>Varža, kOhm</th> </tr> </thead> <tbody> <tr><td>–40°C</td><td>32,34</td></tr> <tr><td>–35°C</td><td>24,96</td></tr> <tr><td>–30°C</td><td>19,48</td></tr> <tr><td>–25°C</td><td>15,29</td></tr> <tr><td>–20°C</td><td>12,11</td></tr> <tr><td>–15°C</td><td>9,655</td></tr> <tr><td>–10°C</td><td>7,763</td></tr> <tr><td>–5°C</td><td>6,277</td></tr> <tr><td>0°C</td><td>5,114</td></tr> <tr><td>+5°C</td><td>4,188</td></tr> <tr><td>+10°C</td><td>3,454</td></tr> <tr><td>+15°C</td><td>2,862</td></tr> <tr><td>+20°C</td><td>2,387</td></tr> <tr><td>+30°C</td><td>1,684</td></tr> <tr><td>+40°C</td><td>1,211</td></tr> <tr><td>+50°C</td><td>0,8854</td></tr> <tr><td>+60°C</td><td>0,6587</td></tr> <tr><td>+70°C</td><td>0,4975</td></tr> <tr><td>+80°C</td><td>0,3807</td></tr> </tbody> </table>	Temperatūra	Varža, kOhm	–40°C	32,34	–35°C	24,96	–30°C	19,48	–25°C	15,29	–20°C	12,11	–15°C	9,655	–10°C	7,763	–5°C	6,277	0°C	5,114	+5°C	4,188	+10°C	3,454	+15°C	2,862	+20°C	2,387	+30°C	1,684	+40°C	1,211	+50°C	0,8854	+60°C	0,6587	+70°C	0,4975	+80°C	0,3807
Temperatūra	Varža, kOhm																																								
–40°C	32,34																																								
–35°C	24,96																																								
–30°C	19,48																																								
–25°C	15,29																																								
–20°C	12,11																																								
–15°C	9,655																																								
–10°C	7,763																																								
–5°C	6,277																																								
0°C	5,114																																								
+5°C	4,188																																								
+10°C	3,454																																								
+15°C	2,862																																								
+20°C	2,387																																								
+30°C	1,684																																								
+40°C	1,211																																								
+50°C	0,8854																																								
+60°C	0,6587																																								
+70°C	0,4975																																								
+80°C	0,3807																																								

Sertifkatas	CE ženklas. EMS pagal EN 50081-1/2 dėl spinduliuotės ir EN 50082-1/2 dėl atsparumo. Slėgio bandymo rutuliuku temperatūra +100°C band. (DIN EN 60730 / VDE 0631-1) Nominali impulsinė įtampa: III viršįtampio kategorija III (DIN EN 60730/ VDE 0631-1)
-------------	--

## Jutiklio konfigūravimas aukštesnės temperatūros intervalams nustatyti

Nustatyti temperatūros intervalus iki 250 °C, PT100 tipo jutiklis gali būti prijungtas naudojant jutiklio papildinio modulį SM-PT-100-1 (PCN: 1244-022441). Norint prijungti šį modulį ir aktyvuoti naujus temperatūros režius, reikia iš naujo nustatyti įrenginį.

Jutiklis			
	Standartinis	Su SM-PT100-1 modulių	
	(yra dėžutėje)	HARD-78	MONI-PT100-260/2
Temperatūros jutiklio tipas	NTC 2 K $\Omega$ m / 25°C, 2 laidų	PT100	PT100
Jutiklio antgalio matmenys	Ø 5 mm, ilgis 20 mm	Ø 6 mm, ilgis 50 mm	Ø 6 mm, ilgis 50 mm
Jutiklio kabelio ilgis	5 m	3 m	2 m
Kabelio pratęsimas	Iki 150 m, min. 2 x 1,5 mm <sup>2</sup>	Iki 150 m, 3 x 1,5 mm <sup>2</sup>	Iki 150 m, 3 x 1,5 mm <sup>2</sup>
Temperatūros ribos	-40 °C iki +90 °C	-40°C iki +150°C	-50°C iki +260°C

## NAUDOJIMAS

„Raystat V5“ įrenginyje yra naudotojo sąsaja – šviesadiodis ekranas:

Įrenginyje automatiškai atidaromas pagrindinis ekranas, jei parametų įvedimo ekrane 2 minutes neatliekama veiksmų.

### Greitasis diegimas

Kai įrenginys įjungiamas pirmą kartą, reikia paruošti jį darbui atliekant trumpą sąranką. Greitojo paleidimo funkcija padeda nustatyti visus svarbius parametrus, o baigus įrenginys automatiškai persijungia į pagrindinio ekrano režimą. Greitojo paleidimo pakanka įprastinėms operacijoms. Esant specialioms montavimo sąlygoms, parametų meniu galima rasti daugiau parametų.

Greitojo paleidimo funkcija pasileis tik jei prieš tai nebuvo nustatyta jokių parametų.

**Greitasis paleidimas ➡ 64**

**Parametų nustatymai ➡ 71**

## Parametrų apžvalga:

PARAMETRAS	Darbo režimas: PiPE	Darbo režimas: Air = PASC	Aprašymas	Gamykliniai parametrai	Parametrus
SP1	✓	✓	NUSTATYTA temperatūra	+3°C	0°C ... +90°C
SP2	✓	✓	Darbo režimo pasirinkimas	----	PiPE / Air
SP3		✓	Žemiausia aplinkos temperatūra	-20°C	-30°C ... 0°C
SP4		✓	Vidutinis vamzdžio skersmuo	2 >= DN 25 / 1"	01 = Ø < DN 25 / 1" 02 = Ø ≥ DN 25 / 1" 03 = Ø ≥ DN 50 / 2"
SP5	✓	✓	Šildytuvo veikimas jutiklio gedimo režimu	ON	ON/OFF
SP6	✓	✓	Šildytuvo valdymas per išorinį kontaktorių	No	Yes/No
SP7	✓		Histerezė	1 K	0 K ... 5 K
SP8	✓		Žemos temperatūros signalas	0°C	OFF/-40°C
SP9	✓		Aukštos temperatūros signalas	+65°C	OFF/+65°C
SP10	✓	✓	Signalų garsas	ON	ON/OFF
SP11	✓	✓	BANDYMO programa	OFF	ON/OFF
SP12	✓	✓	UŽRAKTAS – slaptažodis	OFF	OFF/code 036
SP13	✓	✓	Atstatyti parametrus	000	Code 012

## Klaidų kodai:

Klaidos kodas	Klaidos aprašymas	Taisomasis veiksmas
Er 2.1	Atvira jutiklio jungtis	1. Patikrinkite jutiklio kabelio prijungimą 2. Patikrinkite įrenginio veikimą 3. Pakeiskite įrenginį, jei kabelis tinkamas, bet klaida nedingsta
Er 2.2	Jutiklio trumpasis jungimas	1. Patikrinkite jutiklio prijungimą 2. Pakeiskite jutiklį 3. Pakeiskite įrenginį, jei jutiklis tinkamas, bet klaida nedingsta
Er 3.1	Aukštos temperatūros signalas	1. Patikrinkite šildymo sistemą ir jutiklio padėtį 2. Patikrinkite aukštos temperatūros signalo meniu parametrus
Er 4.1	Žemos temperatūros signalas	1. Patikrinkite šildymo sistemą ir jutiklio padėtį 2. Patikrinkite žemos temperatūros signalo meniu parametrus
Er 6.0	Vidinė klaida	Pakeiskite įrenginį

Klaidų kodai bus rodomi praėjus 10 minučių.

## 1.3 NOTE PER L'INSTALLAZIONE

Le attività di installazione e, se necessario, le attività di manutenzione e smontaggio devono essere eseguite da un elettricista qualificato.

L'installazione deve essere compatibile con le norme locali.

Controllare la lunghezza massima del circuito per il proprio interruttore nella tabella seguente:

### Lunghezza massima del circuito a 230 Vca e per interruttore di circuito con curva caratteristica C e temperatura di avvio di 5°C

Se è richiesto l'utilizzo di cavi scaldanti più lunghi è possibile usare più unità su più punti di alimentazione. Si raccomanda di usare pannelli nVent RAYCHEM SBS-FP-xx16A per gestire 3, 6, 9 o 12 circuiti scaldanti

	10XL2-LH	15XL2-LH	26XL2-LH	31XL2-LH
Interruttore	(Prugna)	(Verde)	(Blu)	(Viola)
<b>C 10A</b>	128 m	96 m	73 m	57 m
<b>C 13A</b>	166 m	125 m	94 m	74 m
<b>C 16A</b>	204 m	153 m	116 m	91 m
<b>C 20A</b>	238 m	188 m	142 m	114 m

L'unità nVent RAYCHEM Raystat V5 dispone di un coperchio superiore removibile. Sia la parte superiore che quella inferiore della scatola contengono parti elettroniche e sono collegate l'una all'altra mediante un cavo Ethernet. Alla consegna dell'unità, il coperchio superiore e la parte posteriore sono smontati.

**Avvertenza:** per la protezione da sovratensione (ad esempio in caso di temporale) si raccomanda di usare un dispositivo di protezione esterno.

### Pulizia e manutenzione

Per pulire l'unità Raystat V5 usare solo un panno morbido inumidito, non utilizzare solventi. Non versare acqua direttamente sul dispositivo. Per le installazioni all'esterno si raccomanda di usare una copertura per proteggere il dispositivo da sole e pioggia.

## Descrizione

nVent RAYCHEM Raystat V5 è un termostato di controllo elettronico con display, impianti di allarme avanzati e la capacità di commutare correnti elevate (25 A). L'unità Raystat V5 è progettata per controllare sistemi a cavo scaldante nVent. I cavi scaldanti possono essere comandati (ON/OFF) direttamente dall'unità Raystat V5 o tramite un contattore.

La commutazione diretta dei cavi scaldanti è possibile con valori di carico non superiori a 25 A.

Per valori di carico superiori a 25 A è necessaria una commutazione indiretta mediante un contattore opportunamente dimensionato, controllato da un'unità Raystat V5.

L'installazione e i collegamenti elettrici devono essere eseguiti in conformità alle norme applicabili.

Il dispositivo deve essere installato solo in aree non pericolose. nVent offre altri controlli per l'uso in aree pericolose.



Il sensore deve essere installato. Attenzione: il posizionamento del sensore sul tubo o in aria deve corrispondere alla modalità di funzionamento PiPE o Air. (PASC / controllo della misura della temperatura ambiente). Un'errata assegnazione può portare al congelamento delle tubazioni.

Il contatto di allarme consente la segnalazione a distanza degli errori. Durante la messa in funzione dell'unità si raccomanda di simulare la funzionalità del sensore nella modalità di rilevamento PIPE, poiché la modalità AIR/PASC non è adatta a questo test a causa del ritardo dell'algoritmo PASC. L'unità può essere pre-programmata in modalità di spegnimento tramite caricatore/batteria esterna (da ordinare separatamente) da collegare mediante un cavo USB A-A-e una connessione USB.

## Dati tecnici

<b>Applicazione del prodotto</b>	Solo per cavi scaldanti per la protezione antigelo delle tubazioni nVent RAYCHEM
<b>Caratteristiche elettriche</b>	
Tensione di alimentazione	180-253 Vca; 50/60 Hz
Assorbimento di potenza	5,3 W max
Relè uscita di potenza (cavo scaldante)	25 A / 230 Vca

Terminali di alimentazione	3 x 6 mm <sup>2</sup> max																																								
Terminali dei cavi scaldanti	3 x 6 mm <sup>2</sup> max																																								
Connettori di allarme	3 x 1,5 mm <sup>2</sup> max																																								
Terminale per sensore - Tubazione	2 x 1,5 mm <sup>2</sup> max																																								
Relè di allarme	Relè SPDT, privo di tensione; Capacità max. di commutazione (solo carico resistivo) 1 A/30 Vcc 0,5 A/125 Vca, Max.: 60 Vcc/125 Vca																																								
Impostazioni	Tutte le impostazioni sono memorizzate nella memoria non volatile																																								
Temperatura di esercizio	Temperatura ambiente da -40°C a +40°C																																								
Campo di selezione temperatura	PiPE: da 0°C a +90°C (PT 100 Sensor Module: -40°C ... +250°C: SM-PT100-1; PCN: 1244-022441) Air (PASC): da 0°C a +30°C																																								
<b>Involucro</b>																																									
Materiale	Policarbonato																																								
Dimensioni	210 x 90 x 85 mm																																								
Classe di protezione	IP 65																																								
Peso	990 g																																								
Montaggio	Su guida DIN da 35 mm																																								
Ingressi	2 x M25 e 2 x M20																																								
Temperatura di stoccaggio	Da -40°C a +50°C																																								
Classe di infiammabilità	Categoria D (DIN EN 60730/VDE 0631-1)																																								
<b>Sensore standard (incluso nella scatola)</b>																																									
Tipo di sensore di temperatura	NTC standard 2,0 kOhm a 25°C 2 fili																																								
Dimensioni punta sensore	Ø 5 mm; lunghezza 20 mm																																								
Lunghezza cavo sensore	5 m; estensibile fino a 150 m, 2 x 1,5 mm <sup>2</sup>																																								
Campo di temperatura	Da -40°C a +90°C																																								
Dati del sensore	<table border="1"> <thead> <tr> <th>Temperatura</th> <th>Resistenza in kOhm</th> </tr> </thead> <tbody> <tr><td>-40°C</td><td>32,34</td></tr> <tr><td>-35°C</td><td>24,96</td></tr> <tr><td>-30°C</td><td>19,48</td></tr> <tr><td>-25°C</td><td>15,29</td></tr> <tr><td>-20°C</td><td>12,11</td></tr> <tr><td>-15°C</td><td>9,655</td></tr> <tr><td>-10°C</td><td>7,763</td></tr> <tr><td>-5°C</td><td>6,277</td></tr> <tr><td>0°C</td><td>5,114</td></tr> <tr><td>+5°C</td><td>4,188</td></tr> <tr><td>+10°C</td><td>3,454</td></tr> <tr><td>+15°C</td><td>2,862</td></tr> <tr><td>+20°C</td><td>2,387</td></tr> <tr><td>+30°C</td><td>1,684</td></tr> <tr><td>+40°C</td><td>1,211</td></tr> <tr><td>+50°C</td><td>0,8854</td></tr> <tr><td>+60°C</td><td>0,6587</td></tr> <tr><td>+70°C</td><td>0,4975</td></tr> <tr><td>+80°C</td><td>0,3807</td></tr> </tbody> </table>	Temperatura	Resistenza in kOhm	-40°C	32,34	-35°C	24,96	-30°C	19,48	-25°C	15,29	-20°C	12,11	-15°C	9,655	-10°C	7,763	-5°C	6,277	0°C	5,114	+5°C	4,188	+10°C	3,454	+15°C	2,862	+20°C	2,387	+30°C	1,684	+40°C	1,211	+50°C	0,8854	+60°C	0,6587	+70°C	0,4975	+80°C	0,3807
Temperatura	Resistenza in kOhm																																								
-40°C	32,34																																								
-35°C	24,96																																								
-30°C	19,48																																								
-25°C	15,29																																								
-20°C	12,11																																								
-15°C	9,655																																								
-10°C	7,763																																								
-5°C	6,277																																								
0°C	5,114																																								
+5°C	4,188																																								
+10°C	3,454																																								
+15°C	2,862																																								
+20°C	2,387																																								
+30°C	1,684																																								
+40°C	1,211																																								
+50°C	0,8854																																								
+60°C	0,6587																																								
+70°C	0,4975																																								
+80°C	0,3807																																								

Omologazione	Marchio CE; EMC secondo la EN 50081-1/2 per le emissioni ed EN50082 - 1/2 per l'immunità; temperatura per la prova di pressione della sfera +100°C (DIN EN 60730/VDE 0631-1) Tensione impulsiva nominale: categoria di sovratensione III (DIN EN 60730/VDE 0631-1)
--------------	---

## Installazione del sensore per rilevamento alti valori di temperatura:

Per intervalli di temperatura più alti, fino a 250°C, è possibile collegare un sensore tipo PT100 utilizzando il modulo plug-in per sensori SM-PT-100-1 (codice: 1244-022441). E' necessario fare un reset dell'unità per far riconoscere questo nuovo modulo hardware al dispositivo e per attivare il nuovo campo di temperatura.

Sensore			
	Standard	Con SM-PT100-1 Modulo	
	Incluso nella scatola	HARD-78	MONI-PT100-260/2
Sensore di temperatura Tipo	NTC 2 KOhm / 25°C, 2 fili	PT100	PT100
Dimensioni	Ø 5 mm, lunghezza 20 mm	Ø 6 mm, lunghezza 50 mm	Ø 6 mm, lunghezza 50 mm
Lunghezza cavo	5 m	3 m	2 m
Prolungamento del cavo	Fino a 150 m, min. 2 x 1,5 mm <sup>2</sup>	Fino a 150 m, 3 x 1,5 mm <sup>2</sup>	Fino a 150 m, 3 x 1,5 mm <sup>2</sup>
Intervallo di Temperatura	da -40°C a +90°C	da -40°C a +150°C	da -40°C a +260°C

## FUNZIONAMENTO

L'unità Raystat V5 ha un'interfaccia utente a LED:

L'unità passa alla visualizzazione principale dopo 2 minuti di non interazione con le schermate di immissione dei parametri.

## Configurazione rapida

Alla prima accensione dell'unità, è necessario eseguire una configurazione rapida per iniziare a utilizzarla. Con la configurazione rapida vengono impostati tutti i parametri importanti e, al termine, l'unità entra automaticamente nella modalità di visualizzazione principale. La configurazione rapida è sufficiente per le operazioni comuni. Nel menu di configurazione sono disponibili ulteriori parametri per adattare l'unità a condizioni di installazione speciali.

La configurazione rapida si avvia solo in assenza di preimpostazioni.

**AVVIO RAPIDO ➡ 64**

**IMPOSTAZIONE DEI PARAMETRI ➡ 71**

## Panoramica parametri:

PARAMETRO	Modalità operativa: PiPE	Modalità operativa: Air = PASC	Descrizione	Impostazioni di fabbrica	Parametri
SP1	✓	✓	Temperatura impostata	+3°C	0°C ... +90°C
SP2	✓	✓	Selezione modalità operativa	----	PiPE / Air
SP3		✓	Temperatura ambiente minima	-20°C	-30°C ... 0°C
SP4		✓	Livello diametro tubo medio	2 ≥ DN 25 / 1"	01 = Ø < DN 25 / 1" 02 = Ø ≥ DN 25 / 1" 03 = Ø ≥ DN 50 / 2"
SP5	✓	✓	Funzionamento del circuito scaldante in modalità guasto sensore	ON	ON/OFF
SP6	✓	✓	Funzionamento del circuito scaldante per mezzo del contattore esterno	No	Yes/No
SP7	✓		Isteresi	1 K	0 K ... 5 K
SP8	✓		Allarme di bassa temperatura	0°C	OFF/-40°C
SP9	✓		Allarme temperatura eccessiva	+65°C	OFF/+65°C
SP10	✓	✓	Stato allarme acustico	ON	ON/OFF
SP11	✓	✓	Programma di PROVA	OFF	ON/OFF
SP12	✓	✓	BLOCCO TASTI - Codice	OFF	OFF/code 036
SP13	✓	✓	RESET	000	Code 012

## Codici di errore:

Codice di errore	Descrizione dell'errore	Rimedio
Er 2.1	Sensore aperto	1. Controllare i collegamenti del cavo del sensore 2. Verificare il funzionamento dell'unità 3. Sostituire l'unità se il cavo è OK e l'errore è ancora presente
Er 2.2	Cortocircuito del sensore	1. Controllare i collegamenti del sensore 2. Sostituire il sensore 3. Sostituire l'unità se il sensore è OK e l'errore è ancora presente
Er 3.1	Allarme di alta temperatura	1. Verificare il sistema scaldante e la posizione del sensore 2. Verificare le impostazioni del menu e l'allarme di alta temperatura
Er 4.1	Allarme di bassa temperatura	1. Verificare il sistema scaldante e la posizione del sensore 2. Verificare le impostazioni del menu e l'allarme di bassa temperatura
Er 6.0	Errore interno	Sostituire l'unità

I codici di allarme saranno visualizzato con un ritardo di 10 minuti.

## PART 2 OPERATIONAL MANUAL

### 2.1 PROGRAM START - QUICK START

#### 2.1.1 Quick Start

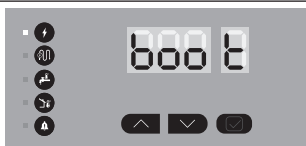

	POWER ON : Flashing, Betriebsanzeige - Blinkend, Mise sous tension : clignotant, SPÄNNING PÅ: Blinkande, SPENNING PÅ: blinkende, VIRTU PÄÄLLÄ: Viikkuu, POWER ON: blinker, Voedingsspanning: Knipperend, ZASILANIE WŁ.: Miga, ZAPNUTO : Bliká, 通电 : 闪烁, ПИТАНИЕ ВКЛЮЧЕНО: Мигает, JUNGTA: mirksi, ALIMENTAZIONE
	Heating cable, Heizband, Ruban chauffant, Värmekabel, Varmekabel, Lämpökaapeli, Varmekabel, Verwarmingskabel, Przewód grzejny, Topný kabel, 伴热电缆, Греющий кабель, Šildymo kabelis, Cavo scaldante
	Pipe/line sensing, Fühlermodus, Anlegerfühler, Détection de la température de la ligne, Temperaturavkänning på röret, Temperaturføler på røret, Putken lämpötilan mittaus, Rørføler, Leidingstemperatuurvoeler, Pomiar temperatury na rurociągu, Čidlo na potrubí, 管线感应, Регулирование по температуре поверхности трубопровода, Vamzdyno temperatūros jutiklis, Rilevamento a contatto
	Ambient sensing, Umgebungsfühler, Détection de la température ambiante, Temperaturavkänning i luften, Omgivelsestemperatur, Ympäristön lämpötilaa mittaava, Luftføler, Omgevingstemperatuurvoeler, Pomiar temperatury otoczenia, Čidlo vzduchu, 环境感应, Регулирование по температуре окружающей среды, Aplinkos temperatūros jutiklis, Rilevamento ambientale
	Alarm, Alarme, Larm, Hälytys, 报警, Тревога, Aliarmas, Allarme

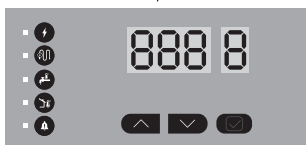

EN	Segment Test
DE	Display Anzeige
FR	Essai segment
SV	Segment test
NO	Segment test
FI	Näyttötesti
DK	Segment test
NL	Test van de LED-segmenten



PL	Test wyświetlacza
CZ	Test segmentů
ZH	区段测试
RU	Тест
LT	Segmento testas
IT	Test segmento

### 2.1.2 Quick Start

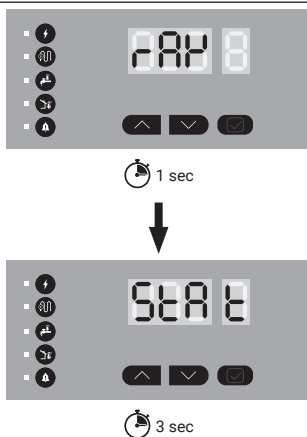

EN	Unit name Raystat Version 5
DE	Gerätename Raystat Version 5
FR	Nom de l'unité Raystat Version 5
SV	Enhetsnamn Raystat version 5
NO	Enhetsnavn Raystat Versjon 5
FI	Ohjaimen nimi: Raystat V5
DK	Enhedsnavn Raystat Version 5
NL	Naam toestel Raystat versie 5
PL	Nazwa jednostki: Raystat wersja 5
CZ	Název jednotky Raystat verze 5
ZH	单元名称 Raystat Version 5
RU	Именованние устройства Raystat версия 5
LT	Jrenginio pavadinimas Raystat Version 5
IT	Nome unità Raystat Version 5

### 2.1.3 Quick Start



3 sec

EN	Firmware Revision number
DE	Firmware Revisionsnummer
FR	Version du logiciel
SV	Firmware revisionsnummer
NO	Firmware revisjonsnummer
FI	Laiteohjelmiston versionumero
DK	Firmware revisionsnummer
NL	Firmware versienummer
PL	Nr rewizji firmware
CZ	Číslo revize firmware
ZH	固件改版编号
RU	Номер версии микропрограммного обеспечения
LT	Programinės įrangos versijos numeris
IT	Numero revisione Firmware

### 2.1.4 Quick Start

#### Parameter

DEFAULT: - - - -

PiPE

Air



EN	Quick start: Select Operation Mode for pipe line (PiPE) or ambient temperatures sensing Air - (PASC - Proportional Ambient Control sensing)
DE	Schnellstart: Wählen Sie den Fühlermodus Anlegerfühler (PiPE) oder Umgebungfühler (Air) aus
FR	Démarrage rapide: choisir mode d'opération pour emplacement sonde (PASC – contrôle proportionnel avec sonde ambiante)
SV	Snabbstart: Välj driftläge för temperaturgivare på rör eller i luft (PASC – Proportionerlig reglering mot omgivningstemperaturen)
NO	Quick start: velg driftsmodus for temperaturføler på rør eller luft (PASC – Proporsjonerlig regulering mot omgivelsestemperaturen)
FI	Pikakäynnistyks: Valitse toimintatila putkelle tai ympäristön lämpötilan mittaamiseen (PASC – Proportional Ambient Control Sensing; ympäristön lämpötilan mittaukseen perustuva suhteellinen ohjaus)
DK	Hurtig start: Vælg driftindstilling for føler på rør eller omgivelsestemperatur (PASC)

NL	Snel start: Selecteer bedrijfsmodus voor leiding-(PiPE) of omgevingstemperatuurvoeler Air - (PASC – Proportional Ambient Control Sensing)
PL	Szybkie uruchomienie: Wybierz Tryb Pracy z powierzchniowym pomiarem temperatury (PiPE) lub pomiarem temperatury otoczenia Air - (PASC – Sterowanie proporcjonalne względem temperatury otoczenia)
CZ	Rychlý start: Zvolte režim spínání dle čidla teploty na potrubí (PiPE), nebo dle okolní teploty vzduchu Air - (PASC proporcionalní řízení dle teploty vzduchu)
ZH	快速启动：选择管线温度感应或环境温度感应（PASC比例环境感应控制）的运行模式
RU	Быстрый запуск: Выберите режим измерения температуры по температуре поверхности или окружающей среды (PASC – пропорциональное регулирование по температуре окружающей среды)
LT	Greitas paleidimas: pasirinkite daviklio (PiPE) ar aplinkos temperatūros režimą Air - (PASC - proporcingas aplinkos temperatūrai valdymas)
IT	Configurazione rapida: Selezionare la modalità operativa per rilevamento linea (PiPE) o temperatura ambiente Air - (PASC - Proportional Ambient Control Sensing)

### 2.1.5 Quick Start

#### Parameter

PiPE:  
0°C... +90°C  
PASC: AIR (PASC)  
0°C... +30°C  
DEFAULT: 3°C



EN	Quick start: Choose Setpoint Temperature
DE	Schnellstart: Eingabe Soll-Temperaturwert
FR	Démarrage rapide: choisir température de consigne
SV	Snabbstart: Välj börvärde temperatur
NO	Quick start: velg setpunkt temperatur
FI	Pikakäynnistys: Valitse asetuspöytätila
DK	Hurtig start: vælg temperature setpunkt
NL	Snel start : Selecteer gewenste temperatuur
PL	Szybkie uruchomienie: Wybierz nastawę temperatury
CZ	Rychlý start: Nastavte požadovanou teplotu
ZH	快速启动：选择设定点温度
RU	Быстрый старт: Выберите уставку температуры
LT	Greitas paleidimas: nustatykite norimą temperatūrą
IT	Configurazione rapida: Scegliere il setpoint di temperatura

### 2.1.6 Quick Start

#### Parameters

DEFAULT: -20°C

🌡️ : -30 - 0°C



EN	(PASC-Air only): Lowest ambient temperature
DE	(nur für PASC-Air gültig): Minimale Umgebungstemperatur
FR	(uniquement pour PASC-Air): Temperature ambiante minimale
SV	(endast PASC-Air): Lägsta omgivningstemperatur
NO	(kun PASC-Air): Laveste omgivelsestemp
FI	(VAIN PASC-Air): Ympäristön alin lämpötila
DK	(kun PASC-Air): Laveste temperatur
NL	(enkel PASC-Air): Laagste omgevingstemperatuur
PL	(tylko tryb PASC-Air): Najniższa temperatura otoczenia
CZ	(pouze PASC-Air): Nejnižší teplota vzduchu
ZH	(仅PASC感应 Air) : 最低环境温度
RU	(только для PASC-Air): Минимально возможная температура окр. воздуха
LT	(tik PASC-Air): Žemiausia aplinkos temperatūra
IT	(Solo PASC-Air): Temperatura ambiente minima

### 2.1.7 Quick Start

#### Parameters



01 =  $\emptyset < \text{DN } 25 / 1''$

02 =  $\emptyset \geq \text{DN } 25 / 1''$

03 =  $\emptyset \geq \text{DN } 50 / 2''$

DEFAULT: 01



EN	(PASC-Air only): Average pipe diameter level
DE	(nur für PASC-Air gültig) Durchschnittlicher Rohrdurchmesser Level
FR	(PASC-Air uniquement) Moyenne de diamètre de la tuyauterie
SV	(endast PASC-Air): Nivå på medelvärde rördiameter
NO	(kun PASC-Air): Gjennomsnittlig rørdiameter
FI	(Vain PASC-Air): Putken keskihalkaisija
DK	(kun PASC-Air): Gennemsnit rørdiameter
NL	(enkel PASC-Air): Gemiddelde buisdiameter
PL	(tylko tryb PASC-Air): Poziom średniej średnicy rurociągu

CZ	(pouze PASC-Air): Průměrná hodnota všech průměrů potrubí
ZH	设定点SP4 (仅PASC-Air 感应) : 平均管道直径等级
RU	(только для PASC-Air): уровень среднего диаметра трубопровода
LT	(tik PASC-Air): Vidutinis vamzdžio skersmuo
IT	(Solo PASC-Air): Livello diametro tubo medio

### 2.1.8 Quick Start

#### Parameters

YES/NO

DEFAULT: NO



EN	Heater operation via external contactor (only if load is not directly connected)
DE	Heizungsbetrieb über externen Schütz (Abfrage erscheint nur wenn keine Last direkt angeschlossen ist)
FR	Le traçage électrique est activé par un contacteur (dans le cas où celui-ci n'est pas directement raccordé)
SV	Värmeelement via extern kontaktor (endast om lasten inte är direkt ansluten)
NO	Varmeelement via ekstern kontaktor (bare hvis last ikke er direkte tilkoblet)
FI	Lämmityksen käyttö ulkoisen kontaktorin kautta (vain jos kuormaa ei ole kytketty)
DK	Varme via ekstern relæ (kun hvis belastningen ikke er direkte forbundet)
NL	Aansluiting verwarmingskabel via externe contactor (alleen als de belasting niet rechtstreeks is aangesloten)
PL	Załączanie ogrzewania przez zewnętrzny stycznik (tylko gdy przewód grzejny nie jest podłączony bezpośrednio)
CZ	Provozní režim spínání stykačem (pouze v případě, že není zátěž přímo připojena)
ZH	伴热线通过外部接触器运行仅当负载没有直接连接时
RU	Управление обогревом через внешний контактор (только если не подключена никакая нагрузка)
LT	Šildymo valdymas per išorinį kontaktorių (tik tada kai apkrovą nepajungta tiesiogiai)
IT	Funzionamento del circuito scaldante per mezzo di un contattore esterno (solo se non è connesso alcun carico)

## 2.2 DISPLAY

### 2.2.1 Display

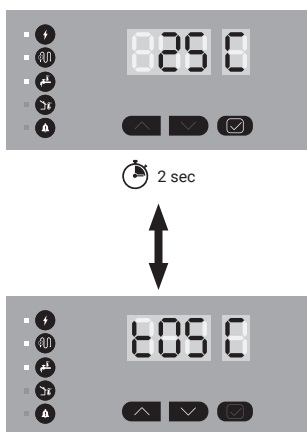

EN	Main display: actual temperature (xxC), setpoint temperature alternating ( txxC)
DE	Hauptanzeige: Aktuelle Fühlertemperatur(xxC) und Sollwerttemperatur (txxC) alternierend angezeigt
FR	Ecran principal: température actuelle (xxC) et température de consigne (txxC) en alternance
SV	Huvudmeny: Aktuell temperatur (xxC) och börvärde (txxC) alternerande
NO	Hovedmeny: Aktuell temperatur(xxC), setpunkt temperatur alternerende (txxC)
FI	Päänäyttö: todellinen lämpötila (xxC), asetuslämpötila vuorotteleva ( txxC)
DK	Hovedmeny: Nuværende temperatur (xxC) og setpunkt (txxC)
NL	Hoofdscherm : afwisselend gemeten temperatuur (xxC) en gewenste temperatuur (txxC)
PL	Wyświetlacz główny: Temperatura aktualna (xxC) naprzemiennie z nastawą temperatury (txxC)
CZ	Hlavní displej: skutečná teplota (xxC), nastavená teplota (txxC), střídají se.
ZH	主显示 : 实际温度 ( xxC ) , 设定点温度交替 ( txxC )
RU	Основной дисплей: текущая температура (xxC), температура поддержания (txxC)
LT	Pagrindinis ekranas: faktinė temperatūra (xxC), keičiama temperatūros vertė (txxC)
IT	Display principale: temperatura effettiva (xxC), setpoint temperatura alternativo (txxC)

## 2.3 PARAMETER SETTING

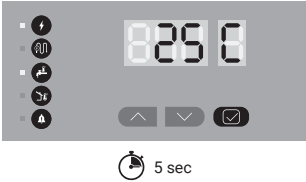
2.3.1 Parameters	
	
EN	Press Check button for 5 sec. to go in Parameter setting. After 30 sec. without input of parameters the unit is set back to main display.
DE	Bestätigungstaste 5 Sek. gedrückt halten um zu den Sollwerteneinstellungen zu gelangen. Nach 30 Sek. ohne Parametereingabe Anzeige springt zur Hauptanzeige.
FR	Appuyer sur le bouton valider pendant 5 sec. pour entrer dans le menu. Après 30 sec. sans saisie de paramètres, l'appareil revient à l'affichage principal.
SV	Tryck på godkännandeknappen i 5 sek. för att gå in i Parameter läge. Efter 30 sekunder utan ändring av parametrar går enheten tillbaka till grundläget.
NO	Press godkjenningsknappen i 5sek. for å gå til parameter modus. Etter 30 sek. uten inntasting av parametere settes enheten tilbake til hovedvisning.
FI	Siirry asetuksiin painamalla OK-painiketta 5 sekuntia. 30 sekunnin kuluttua ilman parametrien syöttämistä laite palautuu takaisin päänäyttötilaan.
DK	Tryk på godkend-knappen i 5 sekunder for at gå i parametertilstand. Efter 30 sek. uden indtastning af parametre går enheden tilbage til hoveddisplayet.
NL	Druk gedurende 5 sec op de bevestigingsknop om in het menu te gaan. Na 30 sec. zonder parameterinvoer gaat de eenheid terug naar het hoofdscherm.
PL	Wciśnij przycisk Zatwierdź przez 5 sek. aby przejść do trybu Parametry. Po 30 sekundach bez wprowadzenia parametrów urządzenie powraca do ekranu głównego.
CZ	Stiskněte tlačítko na 5 sec. pro vstup do nastavení parametrů. Po 30 sekundách bez zadání parametrů se přístroj vrátí na hlavní displej.
ZH	长按确认按键5秒进入参数模式。超过30秒，如果没有输入任何参数，设备将回到主界面。
RU	Нажмите кнопку проверки на 5 сек для перехода в режим настройки параметров. Через 30 сек. без ввода параметров прибор возвращается на главный экран.
LT	Paspauskite ir palaikykite patvirtinimo mygtuką 5 sekundes, kad pasiektumėte parametų meniu. Per 30 sekundžių neatlikus veiksmų, įrenginys sugrįš į pagrindinį meniu.
IT	Premere il pulsante di controllo per 5 sec. per passare alla modalità di definizione dei parametri. Dopo 30 sec. senza l'immissione di parametri l'unità ritorna al settaggio iniziale.

2.3.2 Parameters	
	
EN	Escape from parameter settings
DE	SP1 bis SP 12 Parameter erscheinen, über ESC-Verlassen der Sollwert-Einstellungen
FR	Quitter le paramètre

SV	Gå ur Parameter inställningar
NO	Gå ut fra parameter innstillinger
FI	Poistuu asetuksista.
DK	Forlad parameter indstilling
NL	Verlaat de instellingen
PL	Wyjście z trybu Parametrów
CZ	Ukončit nastavení parametrů
ZH	退出参数设置
RU	Выход из режима настроек параметров
LT	Išeiti iš parametru meniu
IT	Uscita dalle impostazioni dei parametri

### 2.3.3 Parameters

#### Parameters

DEFAULT: 3°C  
 PIPE: 0°C ... +90°C  
 Air: 0°C ... -30°C



EN	Setpoint SP1: Setpoint Temperature
DE	Sollwert SP1: Soll-Temperaturwert
FR	Consigne SP1: température de consigne
SV	Börvärde SP1: Börvärde temperatur
NO	Setpunkt SP1: Setpunkt temperatur
FI	Asetusarvo SP1: Asetuslämpötila
DK	Setpunkt SP1: Setpunkt temperatur
NL	Instelpunt SP1 : Gewenste temperatuur
PL	Nastawa SP1: Nastawa temperatury
CZ	Menu SP1: Požadovaná teplota
ZH	设定点SP1 : 设定点温度
RU	Настройка SP1: Настройка Температуры
LT	Nustatymas SP1: nustatytoji temperatūra
IT	Setpoint SP1: Setpoint di temperatura



### 2.3.4 Parameters

#### Parameters

PiPE

Air



EN	Setpoint SP2: Operation mode (possible to change previously selected parameter with up/down button) for pipe temperature sensing (PiPE) or ambient temperature sensing (Air). Recommendation for pipe sensing: cold water pipes: 3°C; fatty waste water pipes: 40°C
DE	Sollwert SP2: Betriebsmodus für Anlegerfühler (PiPE) (Möglichkeit, den zuvor ausgewählten Parameter mit der Auf-/Ab-Taste zu ändern) oder Umgebungstemperaturgesteuert (Air - PASC). Empfehlung für Rohranlegefühler: bei Kaltwasserleitungen : 3°C ; bei fetthaltigen Abwasserleitungen: 40°C
FR	Consigne SP2: Mode d'opération (possibilité de modifier le paramètre précédemment sélectionné à l'aide du bouton haut/bas) pour la détection de la température des tuyaux (PiPE) ou de la température ambiante (Air). Recommandation pour la détection des conduites : conduites d'eau froide : 3°C ; conduites d'eaux usées grasses : 40°C
SV	Börvärde SP2: Driftläge (möjligt att ändra tidigare vald parameter med upp/ner-knapp) för givarläge (rör) eller avkänning av omgivningstemperatur (luft) Rekommenderat givarläge: rör för kallvatten: 3°C; avloppsrör för feta vätskor: 40°C
NO	Setpunkt SP2: Drift modus (mulig å endre tidligere valgt parameter med opp / ned-knapp) for rørtemperaturregistrering (PiPE) eller sensing av omgivelsestemperatur (luft). Anbefaling for rørføling: kald vannrør: 3 ° C; fettavløpsrør: 40 ° C
FI	Asetusarvo SP2: Toimintatila (aiemmin valittu parametri mahdollista vaihtaa ylänuoli-/alaluolipainikkeella) putkien lämpötilan (PiPE) tai ympäristön tunnistamiseen (Air). Suositus anturiasetuksiin: 3 °C; jätevesiputket rasvaisille nesteille: 40 °C
DK	Setpunkt SP2: Drifttilstand muligt at ændre tidligere valgte parameter med op/ned-knappen) for rørtemperaturføling (PiPE) eller omgivelsestemperaturføling (Air). Anbefaling til rørføling: koldt vandør: 3 °C; fedtet spildevandsør: 40°C
NL	Instelpunt SP2 : Bedrijfsmodus (mogelijkheid om eerdere selectie te veranderen met omhoog/omlaag knop) voor leidingtempertuurvoeler (PiPE) of omgevingstemperatuurvoeler (Air). Aanbeveling voor leidingsvoeler: koud-waterleidingen: 3°C; vethoudende afvoerleidingen: 40°C
PL	Nastawa SP2: Tryb pracy (możliwość zmiany wcześniej wybranego parametru za pomocą przycisków góra/dół) dla czujnika temperatury rurociągu (PiPE) lub czujnika temperatury otoczenia (Air). Zalecenia nastawy dla czujnika temperatury rurociągu: rurociągi zimnej wody: 3°C; przewody kanalizacji tłuszczowej: 40°C
CZ	Menu SP2: Provozní režim (možnost změny dříve zvoleného parametru tlačítkem nahoru/dolů) pro snímání teploty potrubí (PiPE) nebo okolní teploty (Air). Doporučení pro snímání potrubí: potrubí studené vody: 3 °C; potrubí s mastnou odpadní vodou: 40 °C
ZH	设定点SP2：运行模式 改变管道感应温度或环境感应温度（通过上/下按钮，可以改变之前设置参数）。推荐管道感应温度为：3 油脂输送管道：40°C
RU	Настройка SP2: рабочий режим (можно менять ранее выбранный параметр с помощью кнопки вверх/вниз) для определения температуры поверхности трубы (PiPE) или температуры окружающего воздуха (Air). Рекомендации по измерению температуры поверхности трубы: трубы с холодной водой: 3°C; трубы жирных сточных вод: 40°C

LT	Nustatymas SP2: darbo režimas (galima pakeisti anksčiau pasirinktą parametrą su viršun/žemyn rodyklėmis) vamzdžio temperatūrai stebėti (PiPE) arba aplinkos temperatūrai stebėti (Air). Rekomenduojama vamzdžio stebėjimui: šalto vandens vamzdžiai 3 °C; riebalinių nuotekų vamzdžiai: 40 °C
IT	Setpoint SP2: Modalità operativa (è possibile cambiare i parametri selezionati in precedenza con il pulsante su/giù) per il rilevamento della temperatura (del tubo) o dell'aria (Aria). Raccomandazione per rilevamento temperatura: tubi co acqua fredda 3°C; tubi contenenti acqua grassa: 40°C

### 2.3.5 Parameters

#### Parameters

🌡️ : -30°C ....0°C



EN	Setpoint SP3 (PASC-Air only): Lowest ambient temperature
DE	Sollwert SP3: (nur für PASC-Air gültig) Minimale Umgebungstemperatur
FR	Consigne SP3 (uniquement PASC-Air): Température ambiante minimale
SV	Börvärde SP3 (endast PASC-Air): Lägsta omgivningstemperatur
NO	Setpunkt SP3 (kun luft PASC) Laveste omgivelsestemp
FI	Asetusarvo SP3 (vain PASC-Air): Ympäristön alin lämpötila
DK	Setpunkt SP3 ( kun PASC-Air) Laveste temperatur
NL	Instelpunt SP3 (alleen Air-PASC) : Laagste omgevingstemperatuur
PL	Nastawa SP3 (tylko tryb PASC-Air): Najniższa temperatura otoczenia
CZ	Menu SP3 (pouze PASC-Air): Nejnižší teplota vzduchu
ZH	设定点SP3 (仅PASC-空气感应) : 最低环境温度
RU	Настройка SP3 (только для PASC-Air): Минимально возможная температура окр. воздуха
LT	Nustatymas SP3 (tik PASC-Air): Žemiausia aplinkos temperatūra
IT	Setpoint SP3 (solo PASC-Air): Temperatura ambiente minima

### 2.3.6 Parameters

#### Parameters



DEFAULT: 01

01 =  $\emptyset < \text{DN } 25 / 1''$

02 =  $\emptyset \geq \text{DN } 25 / 1''$

03 =  $\emptyset \geq \text{DN } 50 / 2''$



EN	Setpoint SP 4 (PASC-Air only): Average pipe diameter level
DE	Sollwert SP4: (nur für PASC-Air gültig) Durchschnittlicher Rohrdurchmesser Level
FR	Consigne SP4 (PASC-Air uniquement) Moyenne de diamètre de la tuyauterie
SV	Börvärde SP4 (endast PASC-Air): Nivå på medelvärde rördiameter
NO	Setpunkt SP4 (kun luft PASC): Gjennomsnittlig rørdiameter
FI	Asetusarvo SP4 (vain PASC-Air): Putken keskihalkaisija
DK	Setpunkt: SP4 ( kun PASC-Air) Gennemsnit rørdiameter
NL	Instelpunt SP4 (alleen Air- PASC) : Gemiddelde buisdiameter
PL	Nastawa SP4 (tylko tryb PASC-Air): Poziom średniej średnicy rurociągu
CZ	Menu SP4 (pouze PASC-Air): Průměrná hodnota všech průměrů potrubí
ZH	设定点SP4 (仅PASC-空气感应) : 平均管道直径等级
RU	Настройка SP4 (только для PASC-Air): уровень среднего диаметра трубопровода
LT	Nustatymas SP3 (tik PASC-Air): Vidutinis vamzdžio skersmuo
IT	Setpoint SP 4 (solo PASC-Air): Livello diametro tubo medio

### 2.3.7 Parameters

#### Parameters

DEFAULT: ON  
ON/OFF



EN	Setpoint SP5: Heater operation in sensor failure mode
DE	Sollwert SP5: Heizungsbetrieb bei Fühlerfehler (EIN: ON oder AUS: OFF)
FR	Consigne SP5: Activation du traçage en cas de défaut sonde
SV	Börvärde SP5: Driftläge på värme vid fel på temperaturgivare
NO	Setpunkt SP5: Driftmodus på varme ved feil på føler
FI	Asetusarvo SP5: Lämmityksen käyttö anturin vikaantuessa
DK	Setpunkt SP5: Varmekabel indstilling ved følerfejl
NL	Instelpunt SP5 : Werking van verwarmingskabel bij sensorfout
PL	Nastawa SP5: Załączenie ogrzewania w trybie awarii czujnika
CZ	Menu SP5: Provozní režim při poruše čidla
ZH	设定点SP5 : 伴热线在感应故障模式下运行
RU	Настройка SP5: Вариант работы в режиме отказа датчика
LT	Nustatymas SP5: Šildymo režimas jutiklio gedimo metu
IT	Setpoint SP5: Funzionamento del circuito scaldante in modalità guasto sensore

### 2.3.8 Parameters

#### Parameters

YES/NO  
DEFAULT: NO



EN	Setpoint SP6: Heater operation via external contactor
DE	Sollwert SP6: Heizungsbetrieb über externen Schütz

FR	Consigne SP6: Alimentation traçage par contacteur
SV	Börvärde SP6: Värmeelement via extern kontaktor
NO	Setpunkt SP6: Varmeelement via ekstern kontaktor
FI	Asetusarvo SP6: Lämmityksen käyttö ulkoisen kytkimen avulla
DK	Setpunkt SP6: Varme via ekstern relæ
NL	Instelpunt SP6 : Aansluiting verwarmingskabel via extern vermogensrelais
PL	Nastawa SP6: Załączanie ogrzewania przez zewnętrzny stycznik
CZ	Menu SP6: Provozní režim spínání stykačem
ZH	设定点SP6 : 伴热线通过外部接触器运行
RU	Настройка SP6: Управление обогревом через внешний контактор
LT	Nustatymas SP6: Šildymas per išorinį kontaktorių
IT	Setpoint SP6: Funzionamento del circuito scaldante per mezzo del contattore esterno

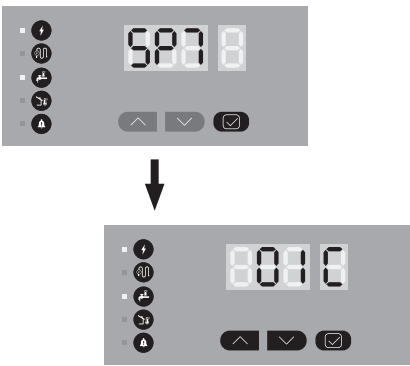
<h3>2.3.9 Parameters</h3> <p><b>Parameters</b> 1-5 DEFAULT: 1</p> 	
EN	Setpoint SP7 (Pipe line only): Hysteresis
DE	Sollwert SP7 (nur für Anlegerfühler Modus) : Hysterese
FR	Consigne SP7 (Sonde sur tuyauterie uniquement): Hysteresis
SV	Börvärde SP7 (Endast givare på rör): Hysteres
NO	Setpunkt SP7(Kun føler på rør): Hysterese
FI	Asetusarvo SP7 (vain putki): Hystereesi
DK	Setpunkt SP7: ( kun ved føler på rør) Hysterese
NL	Instelpunt SP7 (alleen leidingsensor) : Hysteresis
PL	Nastawa SP7 (Tylko w przypadku czujnika na rurze): Histereza
CZ	Menu SP7 (pouze čidlo na potrubí): Hystereze
ZH	设定点SP7 (仅管线感应) : 迟滞
RU	Настройка SP7 (только для управления по температуре поверхности (Line)) Гистерезис
LT	Nustatymas SP7 (tik daviklio režimui): Histerezė
IT	Setpoint SP7 (solo linea): Isteresi

### 2.3.10 Parameters

#### Parameters

OFF/-40°C  
 DEFAULT: 0°C



🌡️ : -40°C - +78°C

EN	Setpoint SP8 (Pipe line only): Low temperature alarm
DE	Sollwert SP8 (nur für Anlegfühler-Modus) : Unterer Temperaturalarm
FR	Consigne SP8 (Sonde sur tuyauterie uniquement) : Alarme température basse
SV	Börvärde SP8 (Endast för givare på rör): Larm för låg temperatur
NO	Setpunkt SP8(Kun føler på rør): Lav temperatur alarm
FI	Asetusarvo SP8 (vain putki): Matalan lämpötilan hälytys
DK	Setpunkt SP8: (kun ved føler på rør) Lav temperatur alarm
NL	Instelpunt SP8 (alleen leidingsensor) : Alarm lage temperatuur
PL	Nastawa SP8 (Tylko w przypadku czujnika na rurze): Alarm niskiej temperatury
CZ	Menu SP8 (pouze čidlo na potrubí): Alarm nízké teploty
ZH	设定点SP8 (仅管线感应) : 低温报警
RU	Настройка SP8 (только для управления по температуре поверхности (Line)) Сигнализация низкой температуры
LT	Nustatymas SP8 (tik daviklio režimui): per žemos temperatūros aliarmas
IT	Setpoint SP8 (solo linea): Allarme di bassa temperatura

### 2.3.11 Parameters

#### Parameters

OFF/65°C

DEFAULT: 65°C



🌡️ : 2°C - 90°C

EN	Setpoint SP9 (Pipe line only): Higher temperature alarm Recommendation: Water pipe lines: max. 65°C; Fatty waste water lines: max. 85°C
DE	Sollwert SP9 (nur für Anlegfühler-Modus): Oberer Temperaturalarm Empfehlung: Heizungsleitungen: max. 65°C; Fetthaltige Abwasserleitungen: max. 85°C
FR	Consigne SP9 (Sonde sur tuyauterie uniquement): Alarme température élevée. Recommandation: Conduites d'eau: max. 65°C; Conduites d'eaux usées grasses: max. 85°C
SV	Börvärde SP9 (Endast för givare på rör): Larm för hög temperatur Rekommendation: Vattenledningar: max 65°C; Avloppsrör för feta vätskor: max 85°C
NO	Setpunkt SP9(Kun føler på rør) Alarm for høy temperatur Anbefaling: Vannrørledninger: maks. 65°C; Fettavløpsrør: maks. 85°C
FI	Asetusarvo SP9 (vain putki): Korkean lämpötilan hälytys . Suositus: Vesiputket: maks. 65 °C; Jätevesiputket rasvaisille nesteille: maks. 85 °C
DK	Setpunkt SP9: ( kun ved føler på rør) Høj temperatur alarm Anbefaling: Vandrørsledninger: max. 65°C; Fedtholdige spildevandsledninger: max. 85°C
NL	Instelpunt SP9 (alleen leidingsensor): Alarm hoge temperatuur. Aanbeveling: Koud-waterleidingen: max. 65°C; Vethoudende afvoerleidingen: max. 85°C
PL	Nastawa SP9 (Tylko w przypadku czujnika na rurze): Alarm wysokiej temperatury Zalecenia: rurociągi z wodą: maks. 65°C; Rurociągi kanalizacji tłuszczowej: maks. 85°C
CZ	Menu SP9 (pouze čidlo na potrubí): Alarm vysoké teploty. Doporučení: Vodovodní potrubí: max. 65 °C; Potrubí odpadní vody s obsahem tuku: max. 85 °C
ZH	设定点SP9 (仅管线感应) : 高温报警 建议 : 水管最高温度为65 °C 油脂废水管道最高温度为85 °C
RU	Настройка SP9 (только для управления по температуре поверхности (Line)) Сигнализация повышенной температуры. Рекомендация: Водопроводные трубы: макс. 65°C; Трубы с жирными стоками: макс. 85°C
LT	Nustatymas SP9 (tik daviklio režimui): per aukštos temperatūros aliarmas Rekomenduojama: vandens vamzdynai: maks. 65 °C; Riebalinių nuotekų vamzdynai: maks. 85 °C.
IT	Setpoint SP9 (solo linea): Allarme temperatura eccessiva Raccomandazioni: Condotture con acqua: max 65°C; Linee di scarico acque grasse: max 85°C

### 2.3.12 Parameters

#### Parameters

ON/OFF

DEFAULT: ON



EN	Setpoint SP10 Alarm sound status
DE	Sollwert SP10 Alarmton
FR	Consigne SP10 Signal sonore
SV	Börvärde SP10 Larmsignal
NO	Setpunkt SP10 Alarmsignal
FI	Asetusarvo SP10 Hälytysäänen tila
DK	Setpunkt SP10: Alarmsignal
NL	Instelpunt SP10 Geluidsalarm
PL	Nastawa SP10 Stan alarmu dźwiękowego
CZ	Menu SP10 Alarm - zvuk bzučáku
ZH	设定点SP10 报警声音状态
RU	Настройка SP10 Звук Сигнализации
LT	Nustatymas SP10 Garsinio signalo statusas
IT	Setpoint SP10 stato allarme acustico



### 2.3.13 Parameters

#### Parameters

YES/NO

DEFAULT: NO

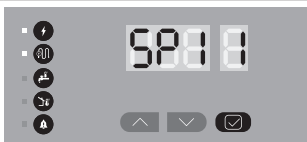

EN	Setpoint SP11: Test program starts, max. 30 min duration
DE	Sollwert SP11: Testprogram starten für eine Zeitdauer von 30 min
FR	Consigne SP11: Le programme de test démarre, max. durée de 30 min
SV	Börvärde SP11: Testprogram startar, varar i max 30 min.
NO	Setpunkt SP11: Test program starter, max. 30min lengde
FI	Asetusarvo SP11: Testiohjelman käynnistyy, kesto enintään 30 min
DK	Setpunkt SP11: Testprogram starter, maks. 30 min
NL	Instelpunt SP11 : Testprogramma start, duurt max. 30 min
PL	Nastawa SP11: Rozpoczyna się program testowy, czas trwania maks. 30 min.
CZ	Menu SP11: Start programu test, max. doba je 30 min.
ZH	设定点SP11: 测试程序启动, 最长持续30分钟
RU	Настройка SP11: Тестю, длится не менее 30 мин
LT	Nustatymas SP11: Testinė programa prasideda, maks. 30 min trukmė
IT	Setpoint SP11: Avvio del programma di prova, durata max. 30 min

### 2.3.14 Parameters

#### Parameters

Code Nr: 036

DEFAULT: 000

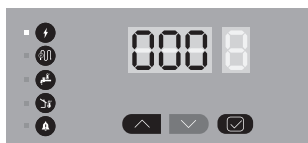

EN	Setpoint SP12: Activate/deactivate Key Lock / code: 036
DE	Sollwert SP12: Tastensperre aktivieren/deaktivieren. Eingabe code ist: 036
FR	Consigne SP12: Activer/désactiver le verrouillage. Code: 036
SV	Börvärde SP12: Aktivera/ deaktivera låsning. Kod: 036
NO	Setpunkt SP12: Aktiver/deaktiver lås. Kode: 036
FI	Asetusarvo SP12: Ota käyttöön / poista käytöstä. Näppäinkoodi: 036
DK	Setpunkt SP12: Aktivere/deaktivere key lock. Kode: 036
NL	Instelpunt SP12: Vergrendeling in-/uitschakelen. Code: 036
PL	Nastawa SP12: Aktywuj/deaktywuj blokadę klawiszy. Kod: 036
CZ	Menu SP12: Aktivace / deaktivace zámku kláves. Kód: 036
ZH	设定点SP12: 激活/取消按键锁定. 代码: 036
RU	Настройка: SP12: Вкл./Выкл. Режимы Блокировки. код: 036
LT	Nustatymas SP12: Įjungti / išjungti mygtukų užrakinimą. Kodas: 036
IT	Setpoint SP12: Attivare/disattivare blocco tasti/codice: 036

### 2.3.15 Parameters

#### Parameters

Code Nr: 012

DEFAULT: 000

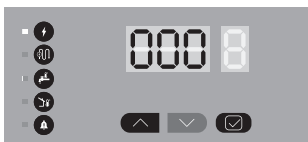

EN	Setpoint 13: Activate RESET to factory settings / code: 012. If Reset is triggered, Quick Start will be activated. Note: If Quick Start is not completed, unit will be set back to last settings.
DE	Sollwert 13: RESET auf Werkseinstellungen aktivieren / Code: 012. Wenn Reset ausgelöst wird, wird Quick Start aktiviert. Hinweis: Wenn der Schnellstart nicht abgeschlossen ist, wird das Gerät auf die letzten Einstellungen zurückgesetzt.
FR	Consigne 13 : Activation du RESET aux paramètres d'usine / code : 012. Si la réinitialisation est déclenchée, le démarrage rapide sera activé. Note : Si le Quick Start n'est pas terminé, l'unité sera remise aux derniers réglages.
SV	Börvärde 13: Aktivera RESET för fabriksinställningar/ kod: 012. Om återställning är aktiverad, kommer Snabbstart att aktiveras. Notera: Om Snabbstart inte är komplett kommer enheten att gå tillbaka till senaste inställningar.
NO	Setpoint 13: Aktiver RESET til fabrikkinnstillinger / kode: 012. Hvis tilbakestilling utløses, vil hurtigstart aktiveres. Merk: Hvis Hurtigstart ikke er fullført, settes enheten tilbake til de siste innstillingene.
FI	Asetusarvo 13: Aktivoi RESET tehdasasetuksiin / koodi: 012. Jos nollaus käynnistetään, pikakäyttöönnotto aktivoituu. Huomaa: Jos pikakäyttöönnotto ei ole valmis, laite palautuu viimeisimpiin asetuksiin.
DK	Setpunkt 13: Aktiver RESET til fabriksindstillingerne/koden: 012. Hvis Reset udløses, aktiveres Quick Start. Bemærk: Hvis Quick Start ikke afsluttes, vil enheden blive sat tilbage til de sidste indstillinger.
NL	Instelpunt SP13: Activatie RESET naar fabrieksinstellingen / code: 012. Wanneer reset getriggerd is, zal de Snelstart geactiveerd worden. Opm.: Wanneer de Snelstart niet volledig is, keert de eenheid terug naar de laatste instellingen.
PL	Nastawa 13: Naciśnięcie RESET przywraca nastawy fabryczne / kod: 012. Jeśli Reset zostanie naciśnięty to następnie zostanie uruchomiona procedura szybkiego startu. Uwaga: Jeśli szybki start nie zostanie zakończony, urządzenie powróci do ostatnich ustawień.
CZ	Nastavená hodnota 13: Aktivujte RESET na tovární nastavení / kód: 012. Pokud je aktivován Reset, aktivuje se Rychlý start. Poznámka: Pokud se Rychlý start nedokončí, jednotka se nastaví zpět na poslední nastavení.
ZH	设定点SP13 : 恢复出厂设置。代码 : 012 如果重启被激活,快速启动将自动激活。 注意:如果快速启动没有完成,设备将回到最后的设置。
RU	Уставка 13: Активация сброса к заводским настройкам / код: 012. Если произойдет сброс, будет активирован быстрый запуск. Примечание: Если быстрый запуск не завершен, устройство будет возвращено к предыдущим настройкам.
LT	Nustatymas 13: Paspauskite RESET atkurti gamyklinius parametrus / kodas: 012. Jei nustatymai yra akuriami, tai įrenginys pasileidžia iš naujo. Pastaba: Jei greitas paleidimas neįvyko, tai įrenginys bus grąžintas į paskutinius parametrus.
IT	Setpoint 13: Attivare il Reset alle impostazioni di fabbrica / codice 012 . Se il Reset viene attivato ,verrà attivato l'avvio rapido. Nota: se l'avvio rapido no viene completato ,il dispositivo ritornerà alle ultime impostazioni

# PART 3 ELECTRICAL SCHEME

Standard: NTC Sensor

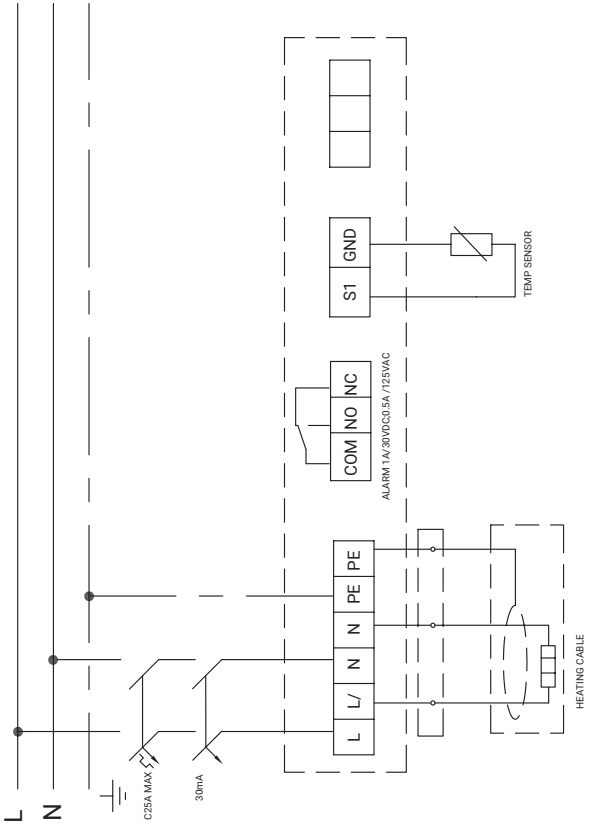

# Electrical Schem

Option: PT100 Sensor

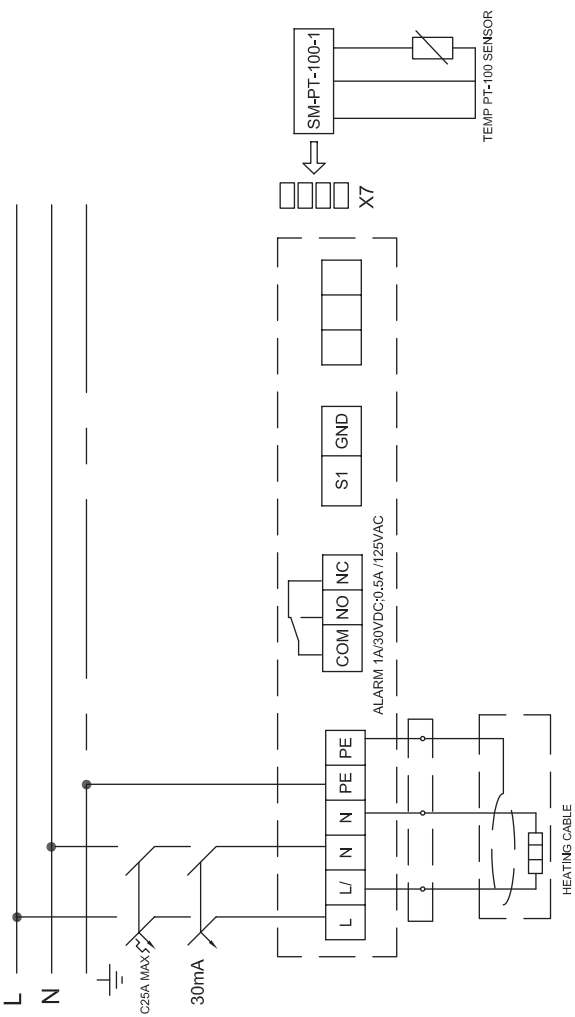

EN	HEATING CABLE
DE	HEIZBAND
FR	RUBAN CHAUFFANT
SV	VÄRMEKABEL
NO	VARMEKABEL
FI	LÄMPÖKAAPELI
DA	VARMEKABEL
NL	VERWARMINGSKABEL
PL	PRZEWÓD GRZEJNY
CZ	TOPNÝ KABEL
ZH	发热电缆
RU	ГРЕЮЩИЙ КАБЕЛЬ
LT	ŠILDYMO KABELIS
IT	CAVO SCALDANTE

EN	ALARM 1A/30VDC; 0.5A /125VAC
DE	ALARM 1A/30VDC; 0.5A /125VAC
FR	ALARME 1 A/30V C.C. ; 0,5 A /125 V CA
SV	LARM 1 A/30 VDC; 0,5 A/125 VAC
NO	ALARM 1 A/30 VDC; 0,5 A/125 VAC
FI	HÄLYTYS 1 A/30 VDC; 0,5 A/125 VAC
DA	ALARM 1 A/30 V DC; 0,5 A /125 V AC
NL	ALARM 1 A/30 VDC; 0,5 A/125 VAC
PL	ALARM 1 A/ 30 VDC; 0,5 A / 125 VAC
CZ	ALARM 1 A / 30 VDC; 0,5 A / 125 VAC
ZH	报警器 1A/30VDC ; 0.5A /125VAC
RU	СИГНАЛ ТРЕВОГИ 1А/30 В пост. ток; 0,5А /125 В перемен. ток
LT	PAVOJAUS SIGNALAS 1 A / 30 V DC; 0,5 A / 125 V AC
IT	ALLARME 1 A/30 Vcc; 0.5 A /125 Vca

EN	TEMP SENSOR
DE	TEMPERATURFÜHLER
FR	SONDE TEMP.
SV	TEMP.GIVARE
NO	TEMPERATURENSOR/FØLER
FI	LÄMPÖTILA-ANTURI
DA	TEMPERATURENSOR
NL	TEMPERATUURENSOR
PL	CZUJNIK TEMPERATURY
CZ	ČIDLO TEPLoty
ZH	温度传感器
RU	ДАТЧИК ТЕМП.
LT	TEMP. JUTIKLIS
IT	SENSORE DI TEMPERATURA

**Worldwide Headquarters**

Tel 800-545-6258  
Fax 800-527-5703  
info@nVent.com

**België / Belgique**

Tel +32 16 21 35 02  
Fax +32 16 21 36 04  
salesbelux@nVent.com

**Česká Republika**

Tel +420 606 069 618  
czechinfo@nVent.com

**China**

Tel +86.21.2412.1688

**Denmark**

Tel +45 70 11 04 00  
salesdk@nVent.com

**Deutschland**

Tel 0800 1818205  
Fax 0800 1818204  
salesde@nVent.com

**España**

Tel +34 911 59 30 60  
Fax +34 900 98 32 64  
ntm-sales-es@nVent.com

**France**

Tél 0800 906045  
Fax 0800 906003  
salesfr@nVent.com

**Italia**

Tel +39 02 577 61 51  
Fax +39 02 577 61 55 / 28  
salesit@nVent.com

**Қазақстан**

Тел +7 7122 325 554  
Факс +7 7122 586 017  
saleskz@nVent.com

**Nederland**

Tel 0800 0224978  
Fax 0800 0224993  
salesnl@nVent.com

**Norge**

Tel +47 66 81 79 90  
salesno@nVent.com

**Österreich**

Tel 0800 29 74 10  
Fax 0800 29 74 09  
salesat@nVent.com

**Polska**

Tel +48 22 331 29 50  
Fax +48 22 331 29 51  
salespl@nVent.com

**Россия**

Тел +7 495 926 18 85  
Факс +7 495 926 1886  
salesru@nVent.com

**Schweiz / Suisse / Svizzera**

Tel +41 (41) 766 3080  
Fax +41 (41) 766 3081  
infoBaar@nVent.com

**Suomi**

Puh 0800 11 67 99  
salesfi@nVent.com

**Sverige**

Tel +46 31 335 58 00  
salesse@nVent.com

**Türkiye**

Tel +90 545 284 09 05  
Fax +32 16 21 36 04  
salesee@nVent.com

**United Kingdom**

Tel 0800 969 013  
Fax 0800 968 624  
salesthermalUK@nVent.com

**Lietuva**

Tel +370 52136634  
saleslt@nVent.com



[nVent.com/RAYCHEM](http://nVent.com/RAYCHEM)

©2021 nVent. All nVent marks and logos are owned or licensed by nVent Services GmbH or its affiliates. All other trademarks are the property of their respective owners. nVent reserves the right to change specifications without notice.

RAYCHEM-IM-EU1535-RaystatV5-ML-2107

PCN 1244-022473