

Hauptsitz:
S&W RohrSysteme GmbH+ Co.KG
 Postfach 110152
 D-31729 Rinteln

Dieselstr. 12
 D-31737 Rinteln

Tel: +49 (0)5751 - 92494- 0
 Fax: +49 (0)5751 - 92494- 24

E-mail: post@s-w-rohrsysteme.de
 Internet: <http://www.s-w-rohrsysteme.de>

S&W-Vertretung Österreich:
Hennlich & Zebisch GesmbH
 A.-Kubin-Str. 9 a-c
 A-4780 Schärding

Tel: +43 (0)7712 - 3163-0
 Fax: +43 (0)7712 - 3163-33

E-mail: dichtungstechnik@hennlich.at
 Internet: <http://www.hennlich.at>

Rohre und Formteile
 nach dem Baukastensystem

Pipes and fittings designed
 on add-a-unit principles

Tuyaux et préformé selon system
 de construction par blocs



Produkte 2018 / Products 2018 / Produits 2018

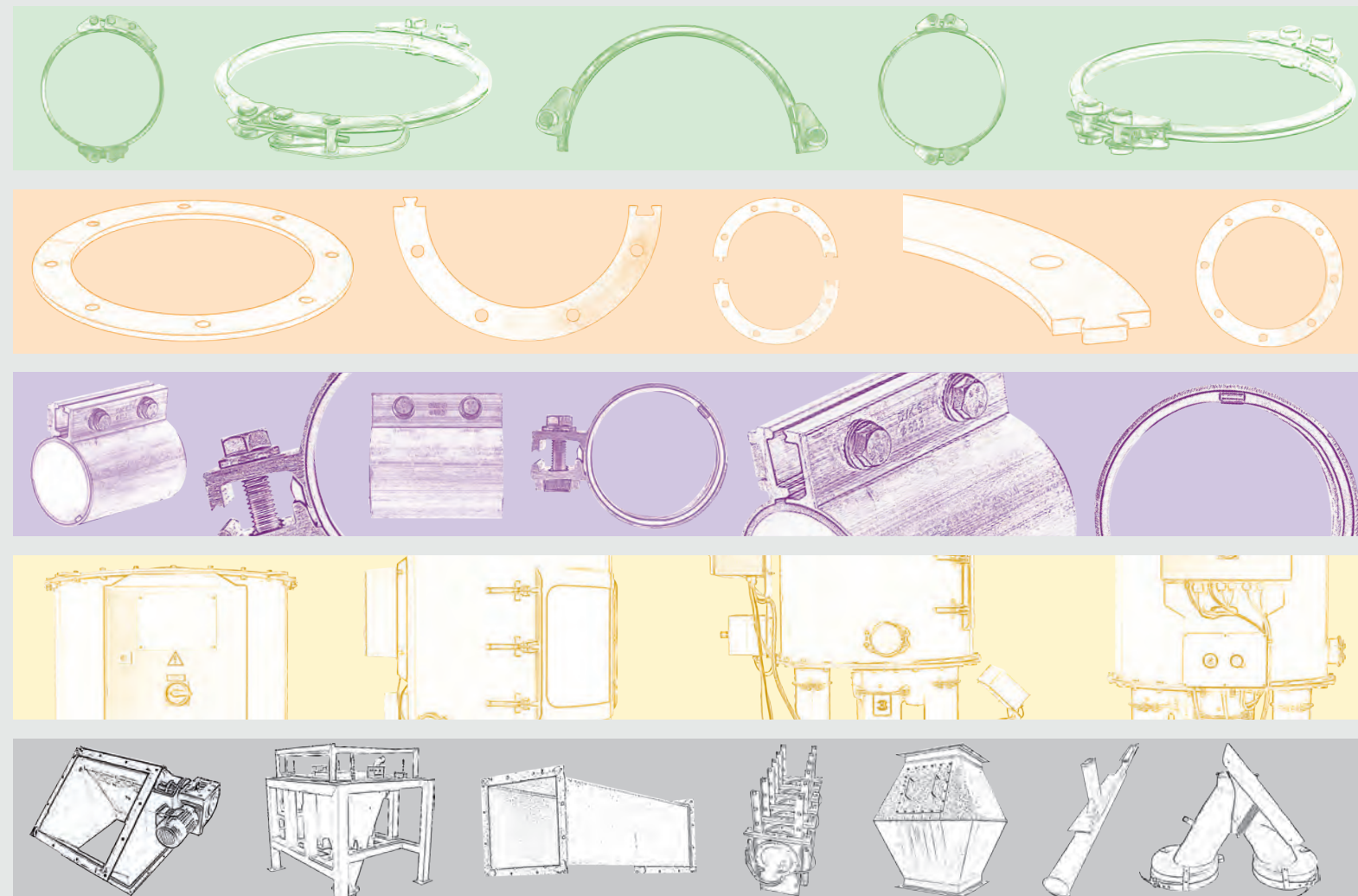

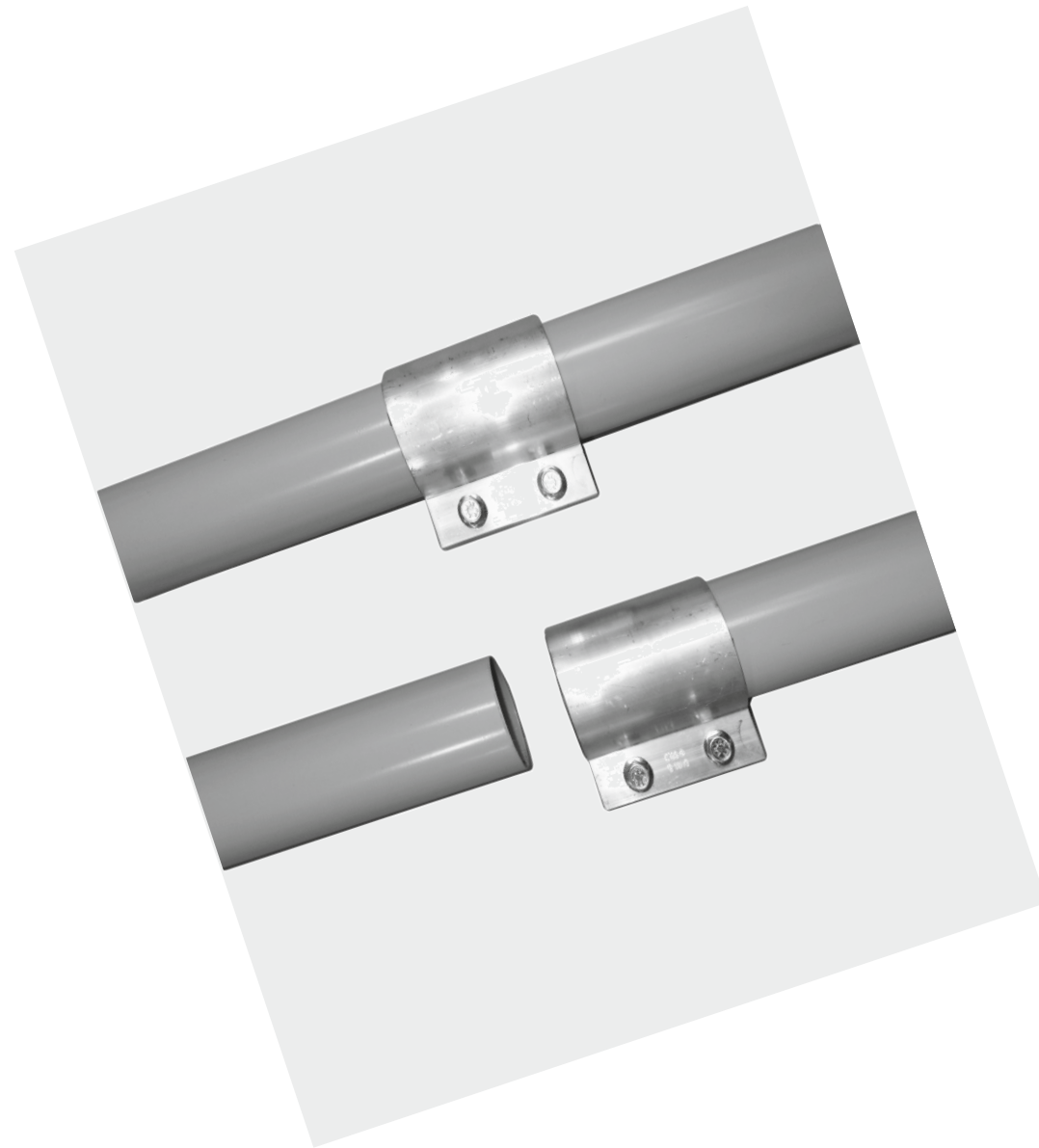

Inhaltsverzeichnis Manschettenrohrbau	Table of contents Pipe collar connection	Table des matières Construction de tubes à manchette	Seite/Page
Rohre 2000 mm lang	Pipes 2000 long	Tuyaux 2000 de long	156
Rohre 1500 mm lang	Pipes 1500 mm long	Tuyaux 1500 mm de long	156
Rohre 1000 mm lang	Pipes 1000 mm long	Tuyaux 1000 mm de long	156
Rohre 500 mm lang	Pipes 500 mm long	Tuyaux 500 mm de long	156
Rohre 250 mm lang	Pipes 250 mm long	Tuyaux 250 mm de long	157
Rohrbogen 90°	Bends 90°	Coudes 90°	157
Rohrbogen 60°	Bends 60°	Coudes 60°	157
Rohrbogen 45°	Bends 45°	Coudes 45°	157
Rohrbogen 30°	Bends 30°	Coudes 30°	158
Rohrbogen 15°	Bends 15°	Coudes 15°	158
T-Stück 90°	T-piece 90°	Pièces en T 90°	158
Gabelstück 30°	Fork-shaped piece 30°	Bifurcation 30°	158
kon. Gabelstück 30°	Conical fork 30°	Bifurcation conique 30°	159
Hosenrohr 60°	Bifurcated Y-pipe 60°	Culotte (Y) 60°	159
kon. Hosenrohr 60°	Conicalbifurcated Y-pipe 60°	Culotte (Y) conique 60°	159
Konus	Cone	Réduction	159
Adapter Rohrmanschette/Bördel	Adapter sleeve flanged for clamping ring	Adaptateur manchette de tuyau/tuyauterie tombé	160
Endrohr	Ending pipe	Tailpipe	160
Drosselklappe	Throttle valve	Vanne papillon	160
Schlauchsteckdose mit Kappe	Hose socket with cover	Prise de flexible avec bouchon	160
Schlauch	Flexible connection	Tuyau flexible	161
Breitbandschellen für Schlauch	Large strip clamp	Collier de serrage à ruban	161
Rohrmanschetten (Alu)	Pipe collar connection	Construction de tubes à manchette	161
Kombi-Rohrschellen mit Dämmeinlage und Höhenregulierung	Combined pipe clip with insulating insert and with high adjustment	Collier combiné avec isolation intégrée à hauteur réglable	161
System-Standschellen, leichte Ausführung	Combined stationary clip, light weight execution	Collier fixe de système, exécution légère	162

					pulverbeschichtet powder coated acier peint		Edelstahl high-grade steel inox	
NW	R	L	H	h	Art.-Nr.	€	Art.-Nr.	€

Rohre 2000 mm lang
Pipes 2000 mm long
Tuyaux 2000 mm de long

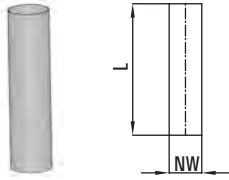

40		2000			0411021	17,91	0413021	65,09
50		2000			0511021	17,91	0513021	65,09
60		2000			0611021	18,53	0613021	67,50

Rohre 1500 mm lang
Pipes 1500 mm long
Tuyaux 1500 mm de long

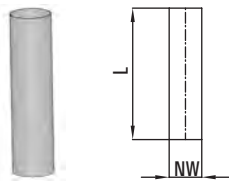

40		1500			0411022	12,36	0413022	54,24
50		1500			0511022	12,36	0513022	54,24
60		1500			0611022	12,98	0613022	56,65

Rohre 1000 mm lang
Pipes 1000 mm long
Tuyaux 1000 mm de long

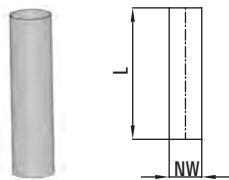

40		1000			0411023	10,51	0413023	36,16
50		1000			0511023	10,51	0513023	36,16
60		1000			0611023	11,11	0613023	37,97

Rohre 500 mm lang
Pipes 500 mm long
Tuyaux 500 mm de long

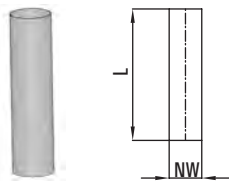

40		500			0411024	7,10	0413024	19,29
50		500			0511024	7,10	0513024	19,29
60		500			0611024	7,42	0613024	21,69

					pulverbeschichtet powder coated acier peint		Edelstahl high-grade steel inox	
NW	R	L	H	h	Art.-Nr.	€	Art.-Nr.	€

Rohre 250 mm lang
Pipes 250 mm long
Tuyaux 250 mm de long

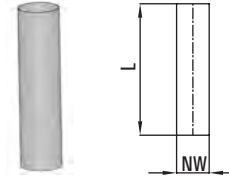

40		250			0411025	4,64	0413025	10,85
50		250			0511025	4,64	0513025	10,85
60		250			0611025	4,78	0613025	12,65

Auch als Schlauchstutzen verwendbar!
Also be used as a hose connection!
Aussi être utilisé comme un embout pour tuyau flexible!

Rohrbogen 90°
Bends 90°
Coudes 90°

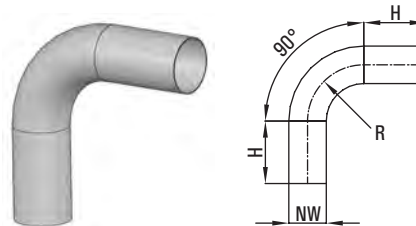

40	R=1,5D		100		0411124	16,54	0413124	33,38
50	R=1,5D		100		0511124	16,54	0513124	33,38
60	R=1,5D		100		0611124	18,04	0613124	35,08

Rohrbogen 60°
Bends 60°
Coudes 60°

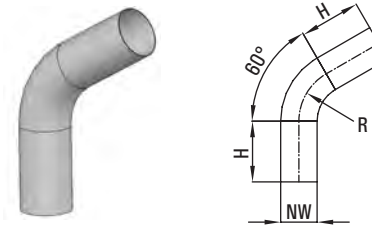

40	R=1,5D		100		0411123	16,54	0413123	33,38
50	R=1,5D		100		0511123	16,54	0513123	33,38
60	R=1,5D		100		0611123	18,04	0613123	35,08

Rohrbogen 45°
Bends 45°
Coudes 45°

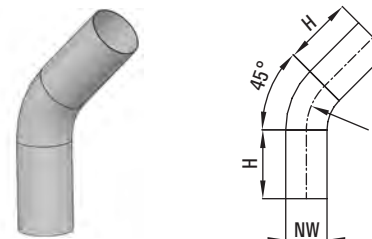

40	R=1,5D		100		0411122	14,34	0413122	29,55
50	R=1,5D		100		0511122	14,34	0513122	29,55
60	R=1,5D		100		0611122	15,73	0613122	31,02

					pulverbeschichtet powder coated acier peint		Edelstahl high-grade steel inox	
NW	R	L	H	h	Art.-Nr.	€	Art.-Nr.	€

Rohrbogen 30°

Bends 30°

Coudes 30°

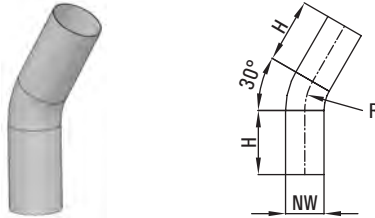

40	R=1,5D		100		0411121	14,34	0413121	29,55
50	R=1,5D		100		0511121	14,34	0513121	29,55
60	R=1,5D		100		0611121	15,73	0613121	31,02

Rohrbogen 15°

Bends 15°

Coudes 15°

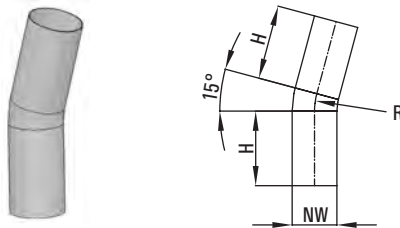

40	R=1,5D		100		0411120	14,34	0413120	29,55
50	R=1,5D		100		0511120	14,34	0513120	29,55
60	R=1,5D		100		0611120	15,73	0613120	31,02

T-Stück 90°

T-pièce 90°

Pièces en T 90°

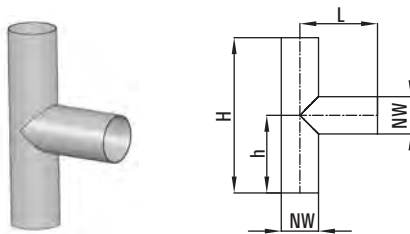

40		85	170	85	0411180	25,24	0413180	68,50
50		85	170	85	0511180	25,24	0513180	68,50
60		85	170	85	0611180	25,75	0613180	70,04

Gabelstück 30°

Fork-Shaped piece 30°

Bifurcation 30°

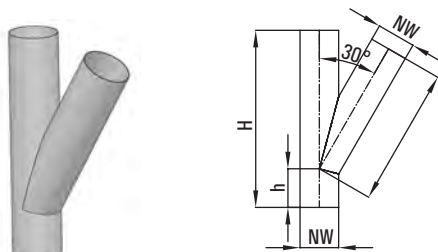

40		215	275	60	0411200	27,40	0413200	71,89
50		215	275	60	0511200	27,40	0513200	71,89
60		215	275	60	0611200	28,84	0613200	72,62

kon. Gabelstück 30°

Conical fork 30°

Bifurcation conique 30°

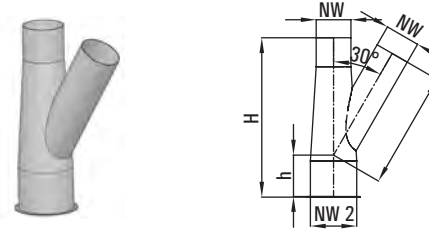

					pulverbeschichtet powder coated acier peint		Edelstahl high-grade steel inox	
NW	NW2	L	H	h	Art.-Nr.	€	Art.-Nr.	€

40	60	202,5	275	71,5	040611200	49,96	040613200	101,07
50	80	202,5	275	71,5	050811200	49,96	050813200	101,07
60	80	202,5	205	71,5	060811200	51,09	060813200	104,24

Hosenrohr 60° (2x30°)

Bifurcation Y-pipe 60° (2x30°)

Culotte (Y) 60° (2x30°)

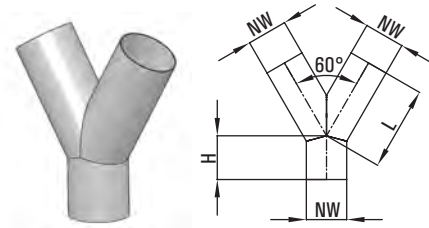

40		125	65		0411210	38,37	0413210	55,62
50		125	65		0511210	38,37	0513210	55,62
60		125	65		0611210	39,96	0613210	58,71

kon. Hosenrohr 60°

Conical bifurcation Y-pipe 60° (2x30°)

Culotte (Y) conique 60° (2x30°)

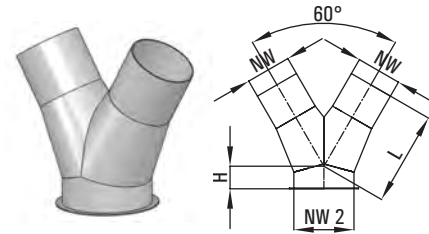

40	60	125	30		040611210	49,96	040613210	101,07
50	80	125	30		050811210	49,96	050813210	101,07
60	80	125	30		060811210	51,09	060813210	104,24

Konus

Cone

Réduction

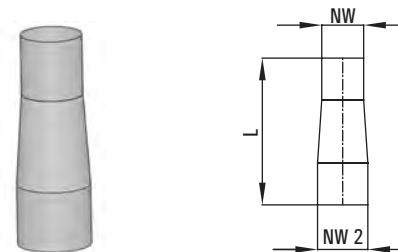

40	50	150			0011315	14,42	0013315	18,54
50	60	150			0011316	14,42	0013316	18,54
60	60	150			0011317	12,73	0013317	15,79

					pulverbeschichtet powder coated acier peint	Edelstahl high-grade steel inox			
NW	NW 2	L	H	h	Art.-Nr.	€	Art.-Nr.	€	

Adapter Rohrmanschette / Bördel

Adapter sleeve flanged for clamping ring

Adaptateur manchette de tuyau / tuyauterie bord tombé

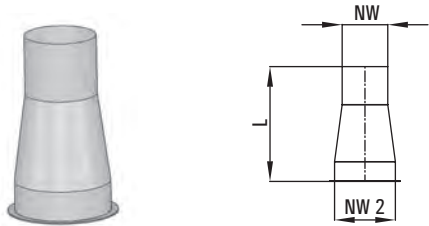

40	80	150			0011314	13,30	0013314	16,92
50	80	150			0011318	13,30	0013318	16,92
60	80	150			0011319	15,73	0013319	16,92

Endrohr

Ending pipe

Tailpipe

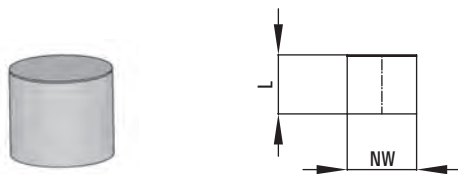

40		50					0413028	12,36
50		50					0513028	12,36
60		50					0613028	13,18

Einseitig mit angeschweißtem Deckel
One side with welded-on cover
Une face avec un couvercle d'ouïe

Drosselklappe

Throttle valve

Vanne papillon

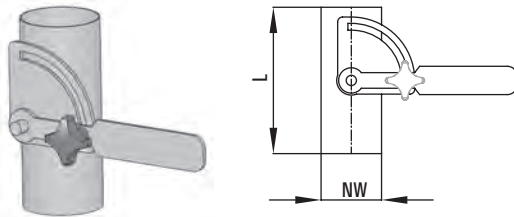

40		150			0411270	41,20	0413270	61,80
50		150			0511270	41,20	0513270	61,80
60		150			0611270	41,20	0613270	61,80

Schlauchsteckdose mit Klappe

Hose socket with cover

Prise de flexible avec bouchon

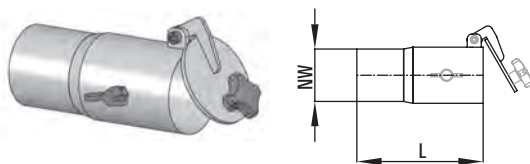

40		150			0411295	46,35	0413295	108,15
50		150			0511295	46,35	0513295	108,15
60		150			0611295	46,35	0613295	108,15

Für Schlauchstutzen/Rohr
For Hose connection / pipe
Pour Embout pour tuyau flexible / tuyau

Schlauch

Flexible connection

Tuyau flexible

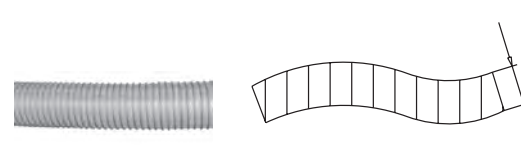

					verzinkt galvanized galvanisé	Aluminium			
NW	di	L	H	h	Art.-Nr.	€	Art.-Nr.	€	

40	40,5				0412045	22,66		
50	51,3				0512045	22,86		
60	60,5				0612045	25,34		

Technische Beschreibung: siehe Seite 32
Technical Remarks on site 32
Remarques techniques voir page 32

Breitbandschellen für Schlauch

Large strip hose clamp

Collier de serrage à ruban

40					0412046	2,68		
50					0512046	2,77		
60					0612046	3,09		

Rohrmanschetten (Alu)

Pipe collar connection

Construction de tubes à manchette



40		100					0412002	7,73
50		100					0512002	8,10
60		100					0612002	9,46

Kombi-Rohrschellen mit Dämmeinlage und Höhenregulierung

Combined pipe clip with insulating insert and with high adjustment

Collier combiné avec isolation intégrée à hauteur réglable

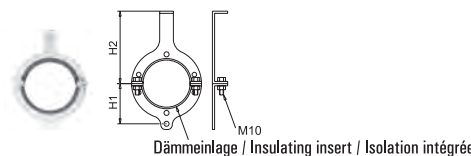

40			115	55	0421050	13,02	0423050	15,00
50			120	60	0521050	13,02	0523050	15,00
60			125	65	0621050	13,02	0623050	15,00

* Edelstahl 1.4301
high-grade steel
inox

					verzinkt galvanized galvanisé	Edelstahl high-grade steel inox			
NW	R	L	H	h	Art.-Nr.	€	Art.-Nr.	€	

System-Standschelle, leichte Ausführung

Combined stationary clip, light weight execution

Collier fixe de système, exécution légère

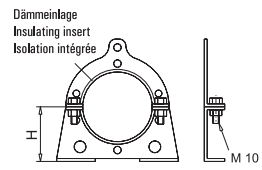
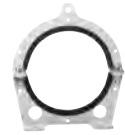

Lochbild siehe Seite 79
Hole pattern on page 79
Schéma de perforation voir page 79

40			48		0421060	19,22	0423060	22,60
50			53		0521060	19,22	0523060	22,60
60			58		0621060	19,22	0623060	22,60